

Sales Training Swiftcolor

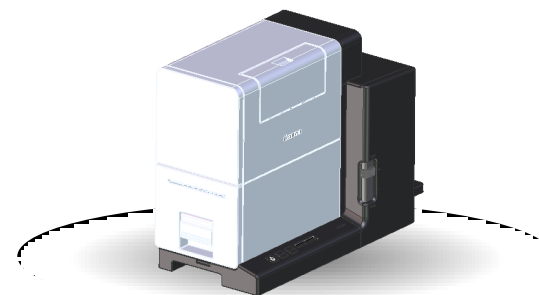

Digital Printer Business Unit of



KANEMATSU CORPORATION

January, 2015

Revision 0.0

For Telephone operator

1. What is difference of INKJET and Thermal Ribbon. (Advantage)
2. Overview of Swiftcolor product
3. General Q&A
4. Recommend Application
5. Price (List Price/Per Print Cost)
6. Durability (Machine/Media)
7. Maintenance
8. Setup
9. How to proceed shipping mode
10. How to use driver functions
 1. Overlay Printing
 2. Pinpoint color print
 3. Supplements
 4. Color matching



For Telephone operator

1. **What is difference of INKJET and Thermal Ribbon. (Advantage)**
2. Overview of Swiftcolor product
3. General Q&A
4. Recommend Application
5. Price (List Price/Per Print Cost)
6. Durability (Machine/Media)
7. Maintenance
8. Setup
9. How to proceed shipping mode
10. How to use driver functions
 1. Overlay Printing
 2. Pinpoint color print
 3. Supplements
 4. Color matching

What is difference of INKJET and Thermal Ribbon. (Advantage)

- ❑ IJ printing Security Merit
- ❑ High Print Quality
- ❑ High Productivity
- ❑ Multi size media Printing
- ❑ Multi Kind Media Printing
- ❑ Broaden Color Space/gamut

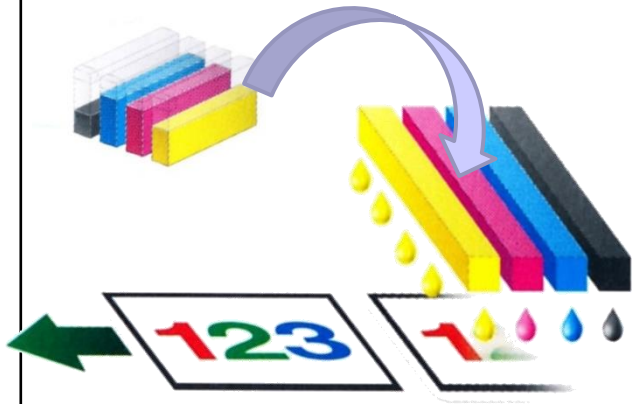
IJ Printing Security Merit

	<u>IJ printing</u>	<u>Thermal transfer printing</u>
Features		
Information protection	No information remains No care about used ink	Printed information remains on the used ink ribbon Must be careful about leak of information
Ink consumption	Ink is used only for printing area No ink is wasted	Entire card range of ribbon is used for every color Most of the ink ribbon is wasted

High Print Quality

1,200dpi print resolution enables to print very clear small characters and small barcodes

Inkjet Card Printer

電驚 abcdefghijklmnop	16pt
電驚 abcdefghijklmnop	14pt
電驚 abcdefghijklmnop	12pt
電驚 abcdefghijklmnop	10pt
電驚 abcdefghijklmnop	8pt
電驚 abcdefghijklmnop	6pt
電驚 abcdefghijklmnop	4pt
電驚 abcdefghijklmnop	2pt

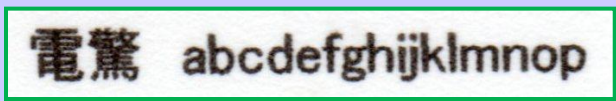

Readability
Good Good Good



(mm)



Thermal Transfer Printer

電驚 abcdefghijklmnop	16pt
電驚 abcdefghijklmnop	14pt
電驚 abcdefghijklmnop	12pt
電驚 abcdefghijklmnop	10pt
電驚 abcdefghijklmnop	8pt
電驚 abcdefghijklmnop	6pt
電驚 abcdefghijklmnop	4pt
電驚 abcdefghijklmnop	2pt

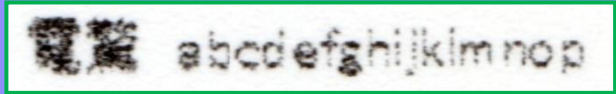

Readability
Bad Bad Bad



(mm)



◆ Product Advantage

High Productivity

Swiftcolor Card Printer



50ppm

Productivity

Thermal Transfer Printer

PR-C201
(Retransfer)



2.4ppm

PR-C101
(Thermal transfer)



2.5ppm

within **10 sec.**

First Print Time

within 24.8 sec.

within 25 sec.

Productivity : 20 times higher
First Print : 2.5 times faster first print time

- + • 1200 dpi high resolution
- Full color with CMYK 4 colors

Multi size media printing

Swiftcolor



Business Card
(55mm x 91mm)



ID CR-80
(54mm x 85.6mm)



Large format
(90mm x 140mm)



Ticket size
(58mm x 172mm)

Thermal Ribbon Printer



ID CR-80
(54mm x 85.6mm)

Inkjet technology could be supported media size variety.
So, many application and new market will be opened.

Multi kind media printing

1) Effective use contributes **cost reduction**

Plastic



Plastic business card
for executives available



You have another choice, using paper !!
Sometimes don't need to use plastic,
using paper contributes **cost reduction** !!

Paper

Temporary/Visitor usage

Stuff ID/Pass

Business Card



(Ex. Office Use)

◆ Product Advantage

Multi kind media printing

2) Multi kind Media Printer works all seasons ,all time.

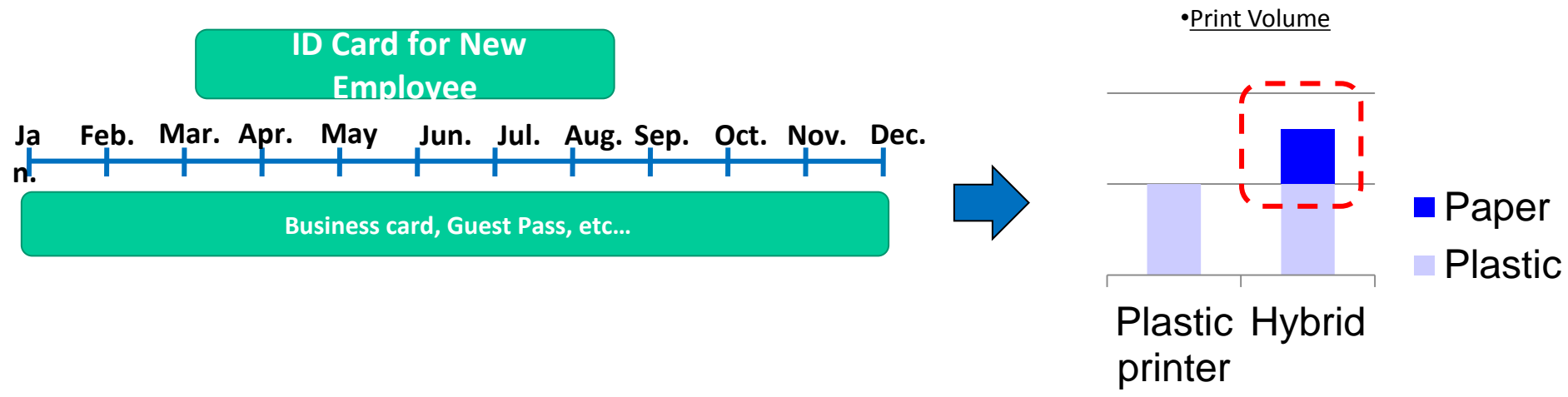

Business Merit

•Chance to get more **supply business**

- Paper media
- Ink for paper



•Chance to get more market
- Office, Retail, Amusement

Color Space/ gamut

Inkjet printer has broader color space in every color (YMCRGB) compared to the dye-sublimation type printer

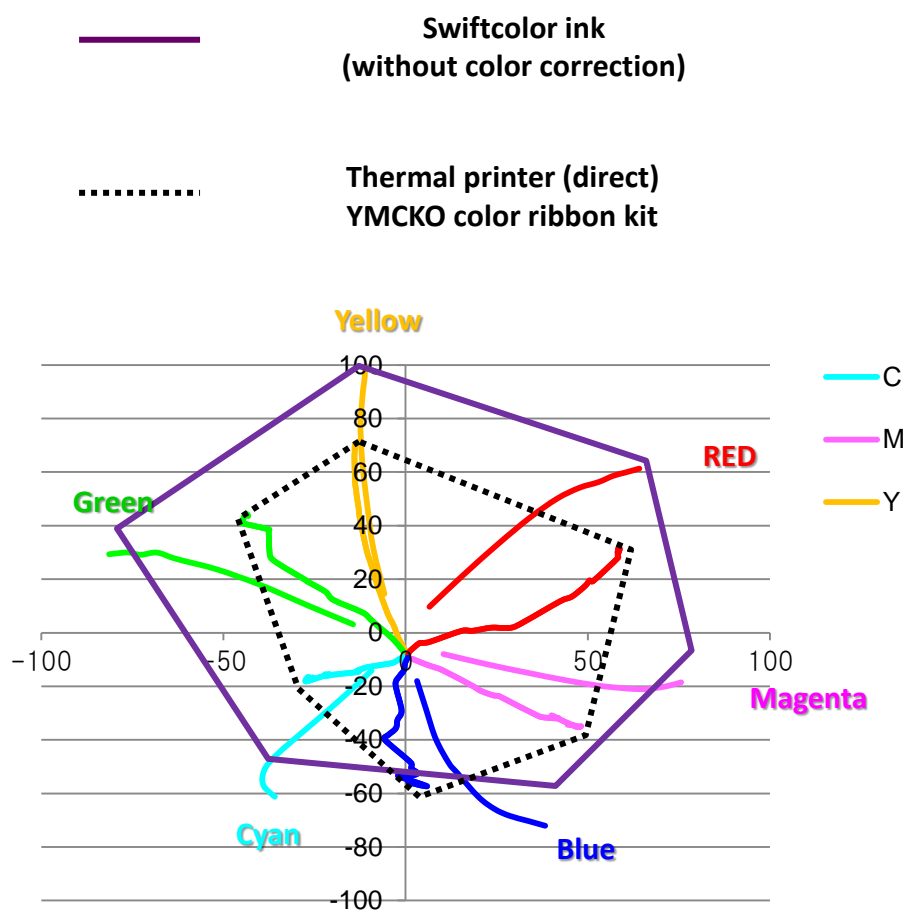

For Telephone operator

1. What is difference of INKJET and Thermal Ribbon. (Advantage)
- 2. Overview of Swiftcolor product**
3. General Q&A
4. Recommend Application
5. Price (List Price/Per Print Cost)
6. Durability (Machine/Media)
7. Maintenance
8. Setup
9. How to proceed shipping mode
10. How to use driver functions
 1. Overlay Printing
 2. Pinpoint color print
 3. Supplements
 4. Color matching

		Swift Color SCC-4000D	Swift Color SCC-2000D
Printing Technology		4" width Single-Pass Inkjet	2" width Single-Pass Inkjet
Photo			
Resolution		1,200 dpi	1,200 dpi
Type of ink		Dye based ink	Dye based ink
Throughput	CR-80 ID card	100 cards / min	50 cards / min
	Business card	100 cards / min	50 cards / min
	90 x 140 mm	45 sheets / min	-
Media		IJ coated Plastic & Paper cards	IJ coated Plastic & Paper cards
Security		No print trace remained	No print trace remained
Print-head Lifecycle *(Business card, 7.5% duty for each color)		1,200,000 prints or 5years	500,000 prints or 5years
# of card print per cartridge		5,000 – 35,000 cards	700 – 3,500 cards



Central mass-production model

**Department, Small sales office,
Branch office, Reception**

	SCC-4000D	SCC-2000D
Print Technology	Inkjet, Single pass printing	Inkjet, Single pass printing
Type of Ink	Dye based ink	Dye based ink
Ink Color	4 colors (Black, Cyan, Magenta & Yellow)	4 colors (Black, Cyan, Magenta & Yellow)
Dimensions	595 (W) x 410 (H) x 463 (D) mm 23.3" (W) x 16.1" (H) x 18.2" (D)	391 (W) x 180 (H) x 179(D) mm 15.4" (W) x 7.0" (H) x 11.0" (D)
Weight	Approx. 25 kg	Approx. 8 kg (Excluding ink tanks)
# of Print-head	4	4
Max. Print Width	107.8mm / 4.24"	57.4mm / 2.26"
Max. Print Length	297.0mm / 11.69"	171.4mm / 6.75"
Data Interface	USB2.0, High speed function Gigabit Ethernet	USB2.0, High speed function Gigabit Ethernet
Power Supply	100 - 240 v, 50 - 60 Hz	100 - 240 v, 50 - 60 Hz
Power Consumption	250w or less	250w or less
Operational environment	15 degreeC/10% - 30 degreeC/80%	15 degreeC/10% - 30 degreeC/80%
Media Size	Width: 85 - 120 mm / 3.35" - 4.70" Length: 49 - 300 mm / 1.90" - 11.81" Thickness: 200 - 760 um	Width: 51 - 58 mm / 2.00" - 2.28" Length: 81 - 172 mm / 3.19" - 6.77" Thickness: 210 - 760 um

	SCC-4000D	SCC-2000D
Print Speed (Copy Mode)	Business card (55 x 91 mm): 100 sheets/min Postcard (100 x 148 mm): 45 sheets/min Envelop (235 x 120 mm): 28 sheets/min	Business card (55 x 91 mm): 50 sheets/min Plastic card (54 x 85.6 mm): 50 sheets/min
Deck Capacity	Business card: 500 sheets Postcard: 500 sheets Envelop: 100 sheets	Business card: 250 sheets Plastic card: 100 sheets
Ink cartridges	105 ml for Bk/C/M/Y each color	14.5 ±0.3ml for Bk/C/M/Y each color

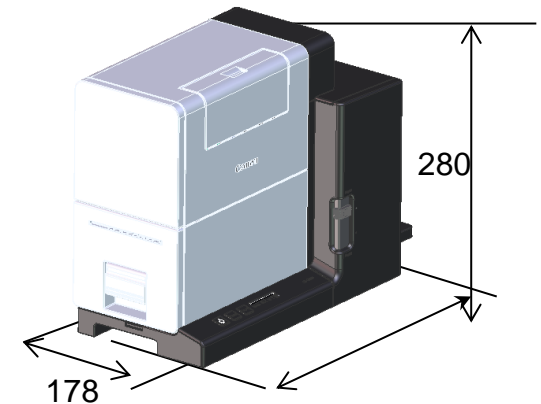
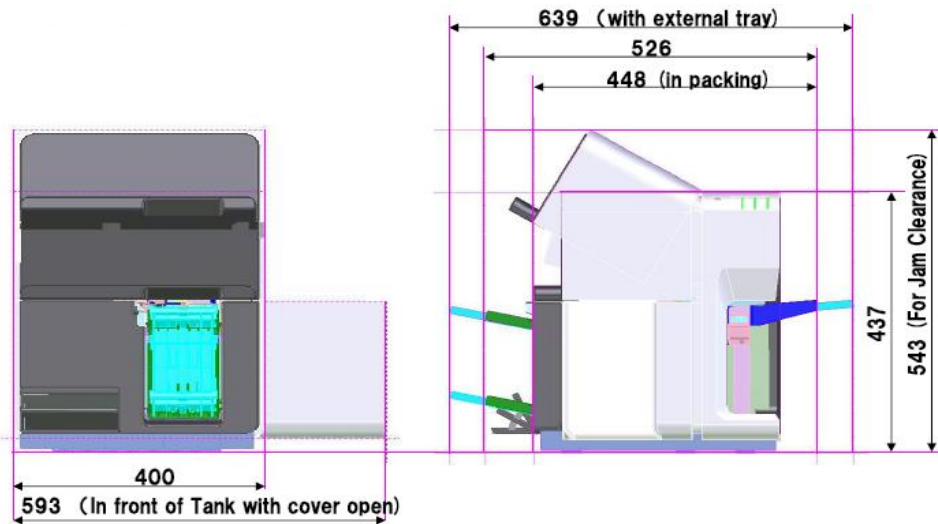

For Telephone operator

1. What is difference of INKJET and Thermal Ribbon. (Advantage)
2. Overview of Swiftcolor product
3. **General Q&A**
4. Recommend Application
5. Price (List Price/Per Print Cost)
6. Durability (Machine/Media)
7. Maintenance
8. Setup
9. How to proceed shipping mode
10. How to use driver functions
 1. Overlay Printing
 2. Pinpoint color print
 3. Supplements
 4. Color matching

General Q&A

Q : Can we print onto general paper/Normal PVC?

A : No, you can't. IJ coated media is required. Please test before use.

Q : What will happen if we print onto general paper/Normal PVC?

A : Sometimes ink adheres to the back side of cards because of lack of ink dryness.

Also, it may cause paper jam, transporting several cards at one time, and skew.

There may occur other troubles except above.

Regarding Normal PVC, this media do not absorb our ink. Thus cannot be used.

Q : Can we print on both side?

A : After printing one side, you need to turn cards over and set them again for printing.

Q : Can we print on edge to edge?

A : No, you can't. However SCC-2000D achieves nearly edge to edge.

SCC-4000D margins "Top/Bottom 1.5mm" and "Right/Left 2.0mm" are needed.

SCC-2000D margins "Top/Bottom 0.3mm" and "Right/Left 0.3mm" are needed.

Q : Which type is the ink Dye type or Pigment type?

A : The ink is Dye type.

Q: How long is Ink Tank guaranteed for working?

A: Within 24 months (Within 6 months after it is installed)

Q: How long is Ink Tank guaranteed for working?

A: Within 24 months (Within 6 months after it is installed)

General Q&A

Q: How long can we use this printer itself?

A: SCC-4000D work for 1.5 million sheets or 5 years.

SCC-2000D work for 0.5 million sheets or 5 years

(General name card's size, Printing coverage is 7.5% duty)

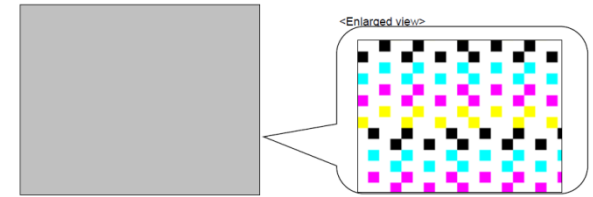

7.5% duty: Standard Image

Q: How often should we exchange maintenance cartridge?

A: SCC-4000D: About 72,000 sheets (Subject to change by using condition)

SCC-2000D: About 35,000 sheets (Subject to change by using condition)

Q: How much does it cost per 1 sheet?

A: It depends on the printing image and your setting.

Please calculate it by "Ink Cost Tool" we offer.

Q: Do we need to clean printer periodically?

A: Yes, you need. Please refer to the chart right.

Q: Can we use this printer by Mac OS?

A: We are sorry, but you can't.

Q: PostScript can be used for this printer ?

A: We are sorry, but it cannot be used.

1	Print head cleaning (via Driver)	When you find Print image failure
1-1	Print head cleaning (Use cleaning stick)	Advanced operation to proceed after #1.
2	Register adjustment	When color gap occurs. In exchanging Print Head.
3	TOF sensor cleaning	Whenever needed
4	Transporting Unit Cleaning	Whenever needed

General Q&A

Q: Does it require Lamination?

A: Depends on use. Laminator should be prepared separately. *Lamination right after printing may cause migration.

Q: Can we print on print RFID cards?

A: Able to print however, requires to input data separately to the RFID.

Q: Are there any consumables other than ink tank?

A: Maintenance cartridge is required to collect maintenance ink.

Replacing timing differs depending on how it is used.

Reference)

Average maintenance ink replacement timing

SCC-4000D : 72,000 sheets with standard condition.

SCC-2000D : 35,000 sheets with standard condition .

For Telephone operator

1. What is difference of INKJET and Thermal Ribbon. (Advantage)
2. Overview of Swiftcolor product
3. General Q&A
- 4. Recommend Application**
5. Price (List Price/Per Print Cost)
6. Durability (Machine/Media)
7. Maintenance
8. Setup
9. How to proceed shipping mode
10. How to use driver functions
 1. Overlay Printing
 2. Pinpoint color print
 3. Supplements
 4. Color matching

Success Case

■ Keyword is replacement XXL Printer

Customer: Famous baseball, American foot ball club and Event company

Printer: SCC-4000D

Application: Large format size card

Advantage: No Pre-Print, print speed;

✓ A customer has 2 concern

1. They can't estimate requirement number of large format card for one event. So, they need to purchase more than enough card because competitor printer need pre-print card.
After changed to SCC-4000D, they didn't care about such wasted expense.
2. Due to event pass, requirement delivery time is really short. So, they need to dispatch special printing person for 24hr printing. After changed to SCC-4000D, they could shorten lead time drastically.

■ Keyword is everyday different information

Customer: Huge Pharmacy Company

Printer: SCC-4000D

Application: Seminar ID Pass

Advantage: On demand Digital Printing

✓ Good point

1. A customer would like to print name as Big size character on front and to print daily schedule on back. So, SCC-4000D really fits this customer's demand
2. A customer print name card when a printer doesn't print Seminar ID Pass.

Employee ID Card and Business Card

Plastic

Or Plastic business card for executives available.

Employee ID



full-time

Corporate Calendar CSR Card



ID Card for New Employee

Jan. Feb. Mar. Apr. May Jun. Jul. Aug. Sep. Oct. Nov. Dec.

Business card, Guest Pass, etc...

Not just a ID card printer, but a Multi purpose printer. it will benefit you all seasons ,all time.

Business Card



外注不要

Paper



Creatively using contributes to cost reduction

Temporary/Visitor

Stuff ID/Pass



Retail Use (Ex. : Retail Shop, Service Industry (Beauty shop, Tax shop))

◆ Reward/member's Card (Plastic) + shop card, service ticket (Paper)

Plastic

Reward/Member's Card

Employee card

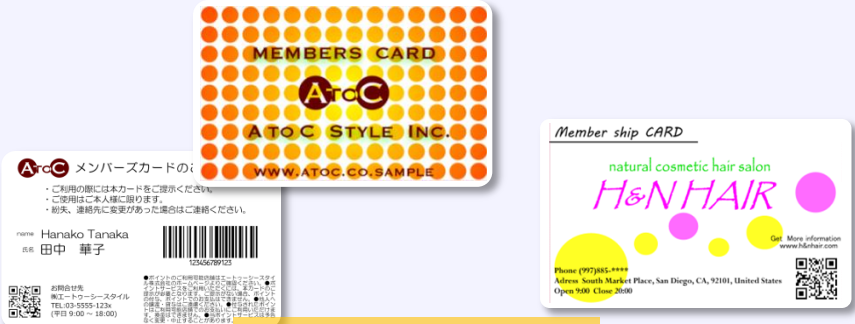

For Repeat Customer



For Entry Customer

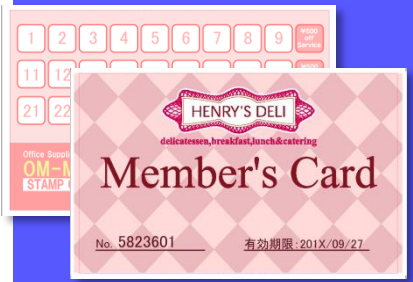

Stamp Reward card



Apparel Price Tag



Service Ticket



Shop card

Raise your business!!

Paper

Amusement Use (Example : Aquarium, Zoo, Amusement/Theme Park, Museum,...)

◆ Annual Pass (1 year durability) and Effective use of Paper Card

Plastic

Annual Pass

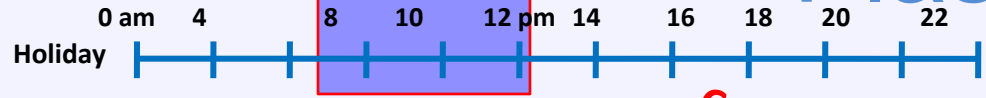

Front

Many customers rush in holiday's morning
Less waiting time
-Saving both customer's and staff's time

Congestion Reducing



High Speed Print



Paper

Creative Use Supports your Daily Business

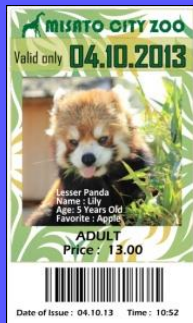

Ticket



Stamp Rally



Memorial Card

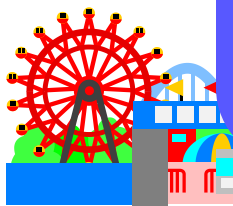

Entertainment Use (Example : Baseball Team, Football Team, Music Group, ...)



◆ Season Ticket, Fun Club Card + Memorial Card



Season Ticket

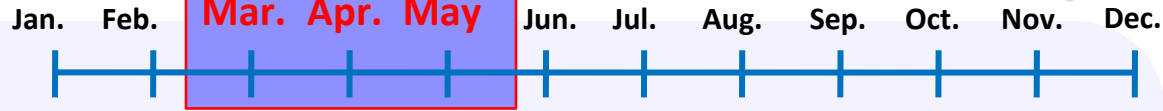

Many fans rush in stadium at the beginning of season, Ellis can print their Passes immediately. You can catch the fun who is very impressed by that game and considering buy season ticket. Don't need to give application form for sending later.

Back



Attract more fans



Music Event Ticket

Ellis's high speed printing enable you to print MVP card in the same day . Thus, your idea can attract more fans.

Also can print temporary event ticket ,for example music live. Thus, one plastic printer accomplish multi purpose.



MVP Baseball Card

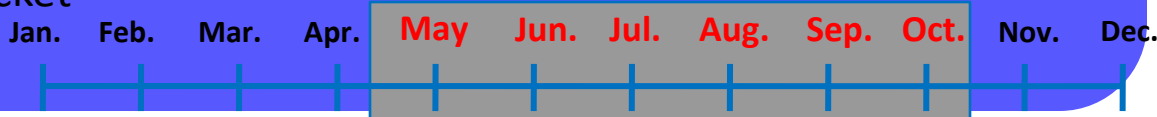

Entertainment Use (Example : Local sports club, Community Facilities, ...)

◆ Member Card, Memorial card, Event Card



Group member card
Attendee card



Community center member card
for use of pool, gym, library...



If he/she did good play in the game,
make memorial Card and give for his/her
Parents !!

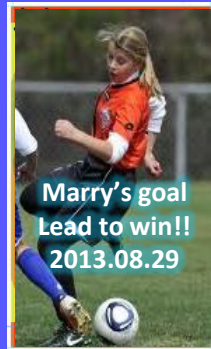

Team/Event Information Card



Memorial Card for praising great job

Contribute Club management

Attracting member!!

Entertain member!!

For Telephone operator

1. What is difference of INKJET and Thermal Ribbon. (Advantage)
2. Overview of Swiftcolor product
3. General Q&A
4. Recommend Application
5. **Price (List Price/Per Print Cost)**
6. Durability (Machine/Media)
7. Maintenance
8. Setup
9. How to proceed shipping mode
10. How to use driver functions
 1. Overlay Printing
 2. Pinpoint color print
 3. Supplements
 4. Color matching

Desk-top Ink Jet Card Printer SCC-4000D

- 1. Printer (SCC-4000D) Euro6,895.-/printer**

- 2. Ink Cartridge (100ml) Euro100.-/cartridge**
4 cartridges (YMC and K) are required.

- 3. Maintenance Cartridge Euro 45.-/cartridge**

The above prices may subject to be changed due to exchange rate without any notice.



Counter-top Ink Jet Card Printer SCC-2000D

- 1. Printer (SCC-2000D) Euro 4,495.-/printer**
- 2. Ink Cartridge (14ml) Euro 25.-/cartridge**
4 cartridges (YMC and K) are required.
- 3. Maintenance Cartridge Euro 29.-/cartridge**

The above prices may subject to be changed due to exchange rate without any notice.

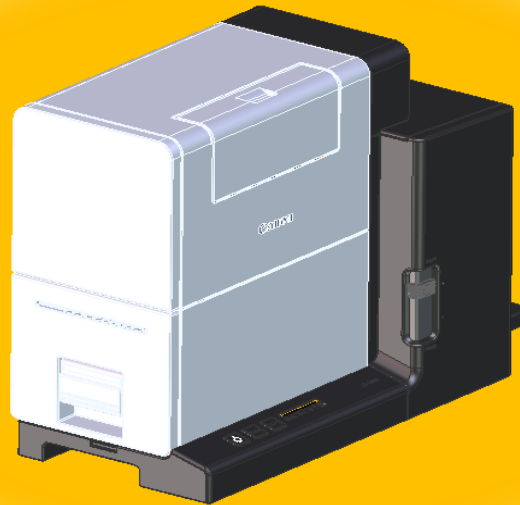

Consumables

3. Cards

1. Business Card

1.	Business Cards (Matte White)	100 cards/set	€2.60/set
2.	Business Cards (Matte Natural)	100 cards/set	€2.60/set
3.	Business Cards (Matte Cream)	100 cards/set	€2.60/set
4.	Business Cards (Thick White)	100 cards/set	€2.60/set

2. Plastic Cards (Mat/Gloss Surface)

1.	CR-80 (85.6mm x 54mm)	250 cards/set	€62.50/set
2.	Large Size (90mm x 140mm)	100 cards/set	€75.00/set

3. Thick Paper Cards

1.	CR-80 (85.6mm x 54mm)	250 cards/set	€37.50/set
2.	Large Size (90mm x 140mm)	100 cards/set	€45.00/set

The above prices may subject to be changed due to exchange rate without any notice.

Image

CR-80 (84mm x 54.6mm)



Color	Media (PVC)	SCC-4000D			SCC-2000D		
		Ink	Cost	Total	Ink	Cost	Total
Black	€ 0.25	0.00243 ml	€ 0.007	€ 0.257	0.00212 ml	€ 0.007	€ 0.257
Cyan		0.00161 ml			0.00094 ml		
Magenta		0.00148 ml			0.00057 ml		
Yellow		0.00115 ml			0.00049 ml		

Image

CR-80 (84mm x 54.6mm)

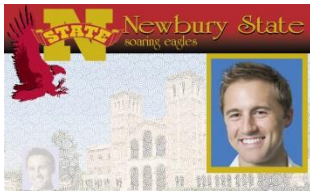

Color	Media (PVC)	Ink	Cost	Total	Ink	Cost	Total
Black	€ 0.25	0.00172 ml	€ 0.020	€ 0.270	0.00236 ml	€ 0.036	€ 0.286
Cyan		0.00326 ml			0.00407 ml		
Magenta		0.00804 ml			0.00692 ml		
Yellow		0.00707 ml			0.00665 ml		

Image

Large (90mm x 140mm)



Color	Media (PVC)	Ink	Cost	Total	Ink	Cost	Total
Black	€ 0.75	0.00360 ml	€ 0.032	€ 0.782	-	-	-
Cyan		0.00832 ml			-		
Magenta		0.00862 ml			-		
Yellow		0.01133 ml			-		

*Print Condition
100print/job

Image

Large (90mm x 140mm)



Condition	Color	Media (PVC)	SCC-4000D			
			Ink	Cost	Total	Printable Number
100print/job	Black	€ 0.75	0.00360 ml	€ 0.032	€ 0.782	27,799 pcs
	Cyan		0.00832 ml			12,025 pcs
	Magenta		0.00862 ml			11,594 pcs
	Yellow		0.01133 ml			8,829 pcs

Image

Large (90mm x 140mm)

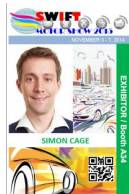

Condition	Color	Media (PVC)	SCC-4000D			
			Ink	Cost	Total	Printable Number
10print/job	Black	€ 0.75	0.01020 ml	€ 0.058	€ 0.808	9,804 pcs
	Cyan		0.01492 ml			6,703 pcs
	Magenta		0.01523 ml			6,567 pcs
	Yellow		0.01793 ml			5,577 pcs

Image

Large (90mm x 140mm)

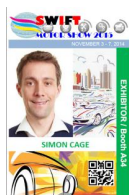

Condition	Color	Media (PVC)	SCC-4000D			
			Ink	Cost	Total	Printable Number
1print/job	Black	€ 0.75	0.07622 ml	€ 0.323	€ 1.073	1,311 pcs
	Cyan		0.08094 ml			1,235 pcs
	Magenta		0.08125 ml			1,230 pcs
	Yellow		0.08395 ml			1,191 pcs

*Regarding SCC-4000D, a print cost and printable number is related with print condition due to auto cleaning process. (SCC-2000D doesn't change much up to print condition.)

*Even print condition has a impact for ink cost, total cost is occupied by media cost.

Plastic Card : **€0.27**
 - Card: €0.25
 - Ink: €0.02

30mil Paper Card : **€0.17**
 - Card: €0.15
 - Ink: €0.02

Paper Card : **€0.046**
 - Card: €0.026
 - Ink: €0.02

Plastic Card : **€0.40**
 - Card: €0.10
 - Ink: €0.30

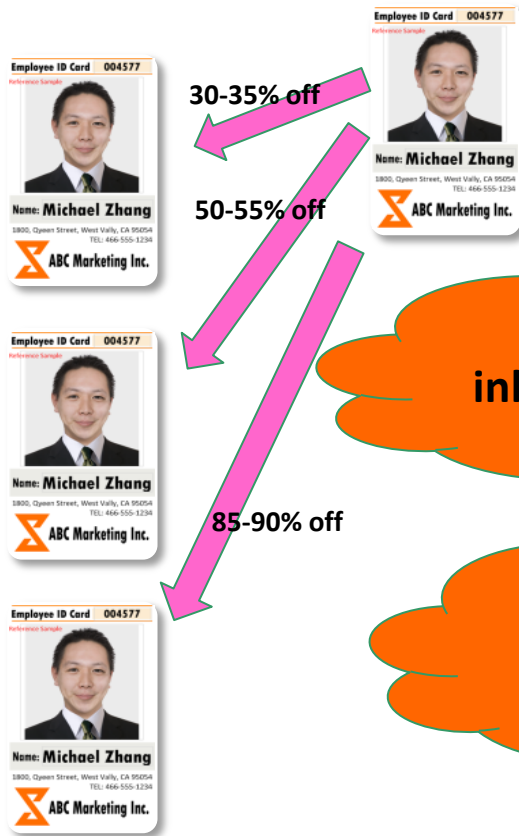

Create new desktop inkjet card printing world



Create paper card market in the current plastic card world



Thermal ID Card Printer

For Telephone operator

1. What is difference of INKJET and Thermal Ribbon. (Advantage)
2. Overview of Swiftcolor product
3. General Q&A
4. Recommend Application
5. Price (List Price/Per Print Cost)
- 6. Durability (Machine/Media)**
7. Maintenance
8. Setup
9. How to proceed shipping mode
10. How to use driver functions
 1. Overlay Printing
 2. Pinpoint color print
 3. Supplements
 4. Color matching

	Swift Color SCC-4000D	Swift Color SCC-2000D
Printing Technology	4" width Single-Pass Inkjet	2" width Single-Pass Inkjet
Photo		
Printer Life	1,500,000 prints or 5years	500,000 prints or 5years
Print-head Lifecycle *(Business card, 7.5% duty for each color)	1,200,000 prints	500,000 prints
Warranty (without warranty)	1 year	1 year
# of card print per ink cartridge	5,000 – 35,000 cards	700 – 3,500 cards
# of card print per maintenance cartridge *(Business card, 7.5% duty for each color)	72,000 cards	35,000 cards
# of card print per cartridge/roll	5,000 – 35,000 cards	700 – 3,500 cards



7.5% duty: Standard Image

■ SCC Ink (Y/M/C/K)

- ◆ Swiftcolor uses water based dye ink. Able to produce vivid color and sharp images.
- ◆ Swiftcolor dye ink has high durable resistance compared to Thermal ribbon.
- ◆ Depending on use, Lamination required in case of exposing to water or chemical (liquids.)

*Ink resistance result depends on used Media, therefore please test before use

■ Media list

1. Business Card
 1. Business Cards (Matte White)
 2. Business Cards (Matte Natural)
 3. Business Cards (Matte Cream)
 4. Business Cards (Thick White)
2. Plastic Cards (Mat/Gloss Surface)
 1. CR-80 (85.6mm x 54mm)
 2. Large Size (90mm x 140mm)
3. Thick Paper Cards
 1. CR-80 (85.6mm x 54mm)
 2. Large Size (90mm x 140mm)

■ Media Durability Test results written in the following pages

【Printer】 SCC-4000D/(160mm/sec)

【Media】 Thick Paper, Matt, Gloss, Direct YMCK, Direct YMCKO, Retransfer

【Conclusion】 Swiftcolor media has enough durability to use under general condition.

Item	Content	Swiftcolor Inkjet			Thermal Ribbon		
		①	③	④	⑤	⑥	⑦
		Thick Paper	Matt	Gloss	Direct YMCK	Direct YMCKO	Retransfer
Durability for plastic 50°C 10Hr Weighted	Plastic Eraser (PVC) TOMBO PE-LTS	Excellent	Excellent	Excellent	Poor (Transferred)	Excellent	Excellent
	Plastic Eraser (PVC-P) KOKUYO KESI-70	Excellent	Excellent	Excellent	Poor (Transferred)	Excellent	Excellent
	Rubber Band	Excellent	Excellent	Excellent	Excellent	Excellent	Excellent
Durability for Scratch 500times	200g weight (Inserting paper: Silbon Paper)	Excellent	Excellent	Excellent	Excellent (Scratch Scar)	Excellent	Excellent
	500g weight (Inserting paper: Silbon Paper)	Acceptable (Little Tailing)	Excellent	Excellent (Scartch Scar)	Excellent (Scratch Scar)	Excellent	Excellent
Durability for Light	100h exposure (1year in room)	Acceptable	Acceptable	Acceptable	Poor	Poor	Poor
Durability for Water	Drop water	Excellent	Acceptable (Ring Stain)	Acceptable (Ring Stain)	Excellent	Excellent	Excellent
Durability for Chemical	Drop Ethanol	Excellent	Excellent	Acceptable (Little Bleeding)	Poor (Bleeding)	Excellent	Excellent
	Drop IPA (kind of Alcohol)	Excellent	Excellent	Acceptable (Little Bleeding)	Poor (Bleeding)	Excellent	Excellent
Remark		Availabel	Available Limited Condition		Unavailable	Available (Short term)	

Color	Swiftcolor Inkjet			Thermal Ribbon		
	Thick Paper	Matt	Gloss	Direct YMCK	Direct YMCKO	Retransfer
Bk	49%	65%	52%	36%	42%	58%
Y	75%	87%	77%	27%	30%	67%
M	71%	52%	67%	35%	44%	58%
C	91%	93%	87%	30%	37%	49%

 : More than 50% Less than 80%

 : Less than 50%

Weather Resistance			Media	①Thick P
Initial				
Drop	Water	1drop		
	EtOH	1drop		
	IPA	1drop		
Dip	Water	5min		
Rubbed (500times)	Dry	200g		
	Dry	500g		
Plasticizer 50°C10Hr	PVC ERASER	PVC-P ERASER		
	rubber band			
Light	0.39W/m ² , 100h			

← Little Tailing

← Yellowish/Migration



Before



After

Weather Resistance			Media	③New Mat
Initial				
Drop	Water	1drop		
	EtOH	1drop		
	IPA	1drop		
Dip	Water	5min		
Rubbed (500times)	Dry	200g		
	Dry	500g		
Plasticizer 50°C10Hr	PVC ERASER	PVC-P ERASER		
	rubber band			
Light	0.39W/m ² , 100h			

← Ring stain

← Yellowish/Migration



Before



After

Weather Resistance			Media	④New Gloss
Initial				
Drop	Water	1drop		
	EtOH	1drop		
	IPA	1drop		
Dip	Water	5min		
Rubbed (500times)	Dry	200g		
	Dry	500g		
Plasticizer 50°C10Hr	PVC ERASER	PVC-P ERASER		
	rubber band			
Light	0.39W/m ² , 100h			

Ring stain

Little bleeding

Little bleeding

Yellowish/Migration



Before



After

Weather Resistance			Media	⑤Direct YMCK
Initial				
Drop	Water	1drop		
	EtOH	1drop		
	IPA	1drop		
Dip	Water	5min		
Rubbed (500times)	Dry	200g		
	Dry	500g		
Plasticizer 50°C10Hr	PVC ERASER	PVC-P ERASER		
	rubber band			
Light	0.39W/m ² , 100h			

Bleeding

Bleeding

Transferred

Yellowish/Migration



Before



After

Weather Resistance			Media	⑥Direct YMCKO
Initial				
Drop	Water	1drop		
	EtOH	1drop		
	IPA	1drop		
Dip	Water	5min		
Rubbed (500times)	Dry	200g		
	Dry	500g		
Plasticizer 50°C10Hr	PVC ERASER	PVC-P ERASER		
	rubber band			
Light	0.39W/m ² , 100h			

Yellowish/Migration



Before



After

Weather Resistance			Media	⑦Retransfer
Initial				
Drop	Water	1drop		
	EtOH	1drop		
	IPA	1drop		
Dip	Water	5min		
Rubbed (500times)	Dry	200g		
	Dry	500g		
Plasticizer 50°C10Hr	PVC ERASER	PVC-P ERASER		
	rubber band			
Light	0.39W/m ² , 100h			

Yellowish/Migration



Before



After

【Printer】 SCC-4000D/(160mm/sec), SCC-20000D

【Media】 Thick Paper, Matt, Gloss

【Circumstance】 JJ: 25°C/40%), LL : 15°C/30%, HH: 30°C/80%

【Image】 Front: ISO(Fruit), Back: Swiftcolor Test Pattern

【Image】 Number: 200pcs/Circumstance

【Check Point】

- Checking feeding condition (accuracy of feeding)
- Checking exit media condition
- Checking shelf test condition



ISO (Fruit)

Slipping Jam

【Media】: Gloss PVC

【Printer】: SCC-4000D

【Problem】: Slipping Jam occur at around separation roller

【Reason】: Mechanically printed side touches the separation assistance pat. In case of printing high density image side first, and flipping over the media to print the blank back side, slipping jam may occur due to high coefficient of friction. (For printing both side)

【Countermeasure】:

1. For printing both side, print low density image at front side and print high density image after.
2. Will change less sticky Gloss media

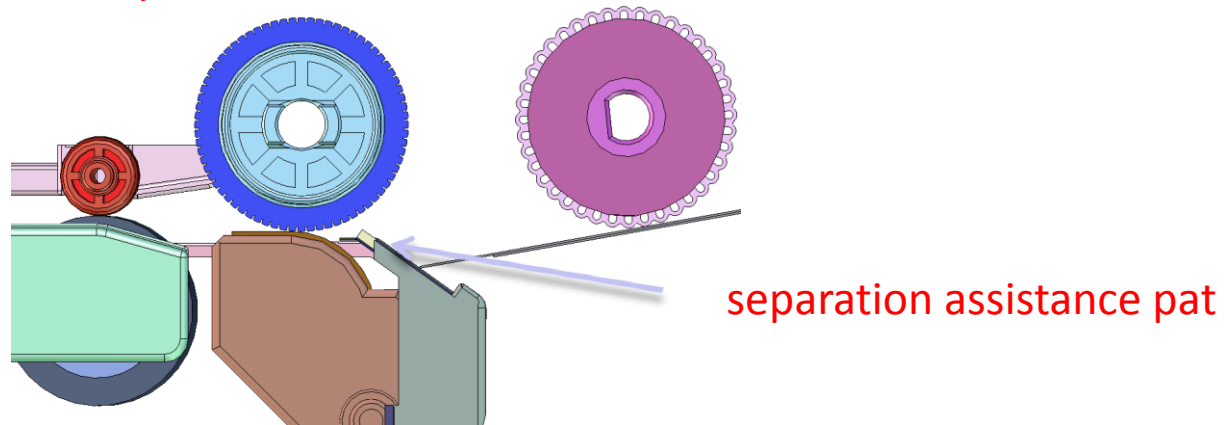

Media Double Feeding

【Media】: Matt PVC

【Printer】: SCC-4000D, SCC-2000D

【Problem】: Media Double Feeding

【Reason】: A flashing at edge of media. And static electronic.

【Countermeasure】:

1. Mass production media use a card shape cutter. So, a flashing will be decreased.
2. A media box include below instruction. Before set up media, please flip through a plastic card.

NOTICE

Check plastic card before print.

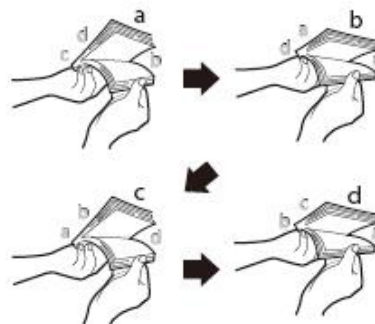

Flip through the plastic card to separate the card.

- Setting the card after flipping through it will prevent multiple sheets from being fed at once.
- Card dust may be adhered to card.

As shown in the figure, flip through the four sides (a, b, c, and d) of the card thoroughly to remove the dust.

Touch Print Head Surface

【Media】: Thick Paper

【Printer】: SCC-2000D

【Problem】: Due to media curling issue, a print head surface touches thick paper media.

【Reason】: Under low humidity circumstance(27 degC 38%), thick media strongly curls and touches the head surface.

SCC-4000D doesn't occur this issue due to guide of media.

【Countermeasure】:



1. Do not set Micro Margin printing with thick paper. (Use the paper guide to flatten the media.)
2. We'll release new thick paper media in 2015.

Summarize feeding test result

			Gloss PVC	Matt PVC	Thick Paper
SCC-4000D	J/J	Feeding	Slipping (only back side printing)	OK	OK
		Image	OK	OK	OK
	L/L	Feeding	Slipping (only back side printing)	Multi feeding After flipping, OK	OK
		Image	OK	OK	OK
	H/H	Feeding	Slipping (only back side printing)	Multi feeding After flipping, OK	OK
		Image	OK	OK	OK
SCC-2000D	J/J	Feeding	OK	OK	OK
		Image	OK	OK	Touch print head surface (Media curling issue)
	L/L	Feeding	OK	Multi feeding After flipping, OK	OK
		Image	OK	OK	OK
	H/H	Feeding	Multi feeding After flipping, OK	Multi feeding After flipping, OK	Multi feeding After flipping, OK
		Image	OK	OK	OK
Shelf test			OK	OK	Under less than 27°C38%, a media will be curling.

For Telephone operator

1. What is difference of INKJET and Thermal Ribbon. (Advantage)
2. Overview of Swiftcolor product
3. General Q&A
4. Recommend Application
5. Price (List Price/Per Print Cost)
6. Durability (Machine/Media)
- 7. Maintenance**
8. Setup
9. How to proceed shipping mode
10. How to use driver functions
 1. Overlay Printing
 2. Pinpoint color print
 3. Supplements
 4. Color matching

	Swift Color SCC-4000D	Swift Color SCC-2000D
Photo		
<u>Customer Maintenance</u>		
Cleaning the transport unit with dry towel	As needed	As needed
Media Pick Up Roller	As needed	As needed
Manual software cleaning	When print quality is poor (Light, Medium, Strong)	When print quality is poor (Light, Medium, Strong)
Registration adjustment	If color registration is out of alignment	If color registration is out of alignment

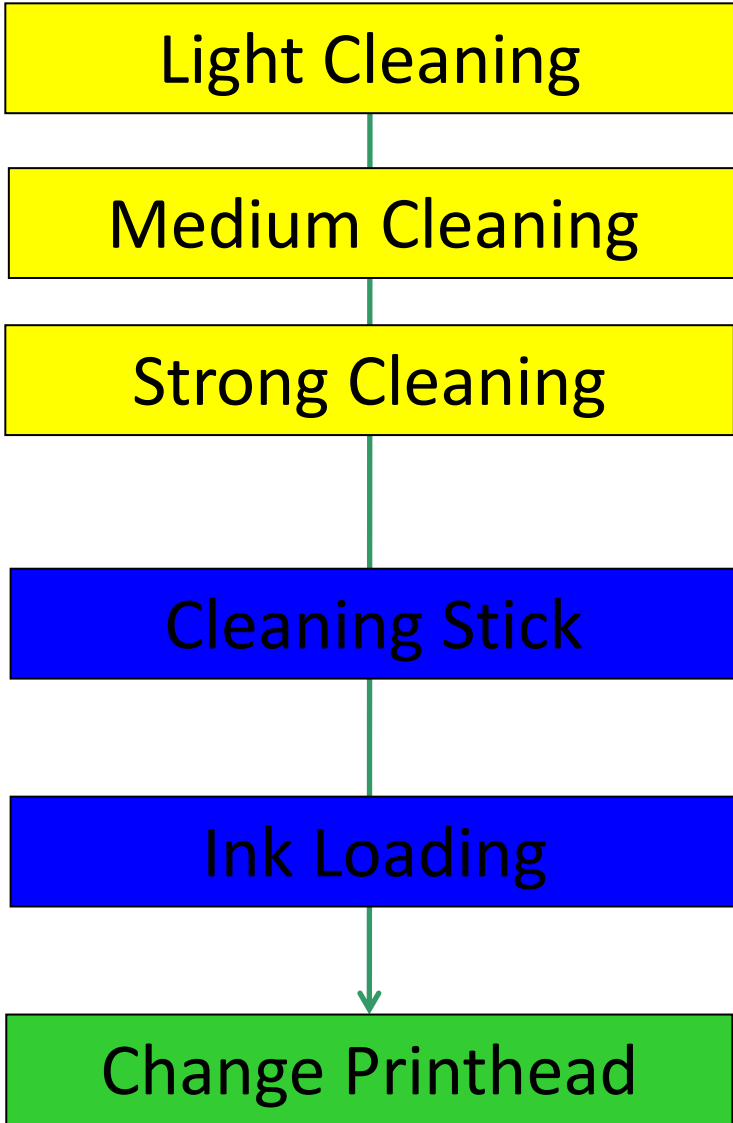

Type	Amount of ink consumed (ml)
Light cleaning	0.8ml/4heads
Medium cleaning	3.2ml/4heads
Strong cleaning	10.0ml/4heads

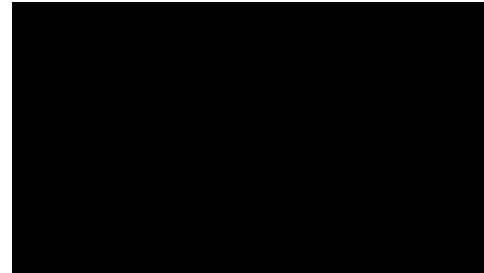

••••• Cleaning method by Service Utility

SCC-4000D Overview :

Please refer to section 1-5, 1-6, 1-7, 1-8 (Component Names) on SWIFTCOLOR SCC-4000D Service Manual.

SCC-2000D Overview :

Please refer to section 1-5 (External View/Internal View) on SWIFTCOLOR SCC-4000D Service Manual.

For Telephone operator

1. What is difference of INKJET and Thermal Ribbon. (Advantage)
2. Overview of Swiftcolor product
3. General Q&A
4. Recommend Application
5. Price (List Price/Per Print Cost)
6. Durability (Machine/Media)
7. Maintenance
- 8. Setup**
9. How to proceed shipping mode
10. How to use driver functions
 1. Overlay Printing
 2. Pinpoint color print
 3. Supplements
 4. Color matching

Please see video;

SCC-4000D: <http://www.swiftcolor.com/SCC4000-setup-video.php>

SCC-2000D:



Please see manual;

SCC-4000D: SCC-4000D Start Guide.pdf

SCC-2000D: SCC-2000D Set Up Guide.pdf

For Telephone operator

1. What is difference of INKJET and Thermal Ribbon. (Advantage)
2. Overview of Swiftcolor product
3. General Q&A
4. Recommend Application
5. Price (List Price/Per Print Cost)
6. Durability (Machine/Media)
7. Maintenance
8. Setup
- 9. How to proceed shipping mode**
10. How to use driver functions
 1. Overlay Printing
 2. Pinpoint color print
 3. Supplements
 4. Color matching

[Draining ink]

1. Connect PC to Printer and start Service Utility.
2. Open [Cleaning] tab and click [Shipping the printer].
(Returns ink in the ink flow path to Ink Tank.)
3. Remove Ink Tanks when the following message is displayed.
4. Close Ink Tank Door.
(Feeds back ink in nozzles and Purge Unit to Maintenance Cartridge.)

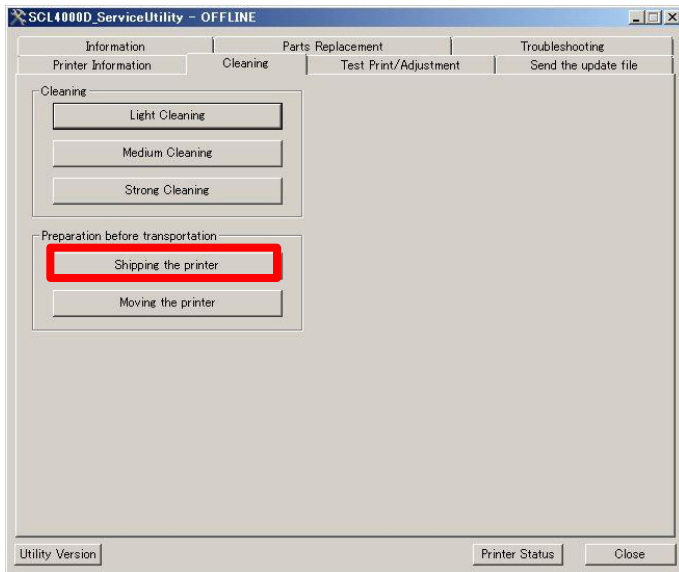

CAUTION:
Do not operate Printer until the message is displayed.

[Draining ink]

1. Ink drainage is completed when the following message is displayed.

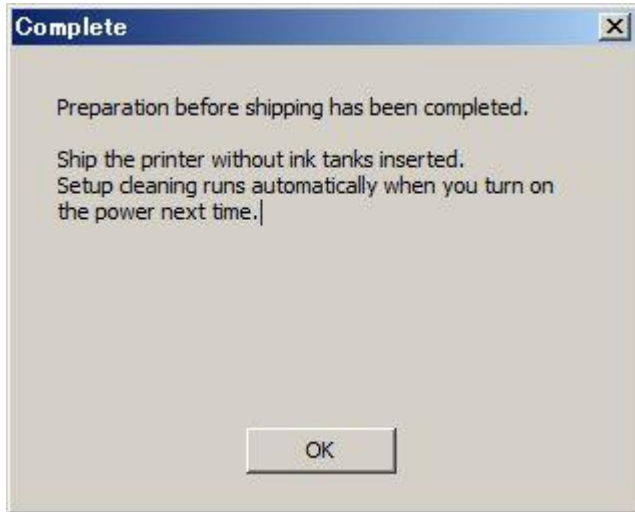

CAUTION:
Do not operate Printer until the message is displayed.

2. Turn off the power and remove Power Cable.

[Packing]

1. Attach cushions (at 3 positions).

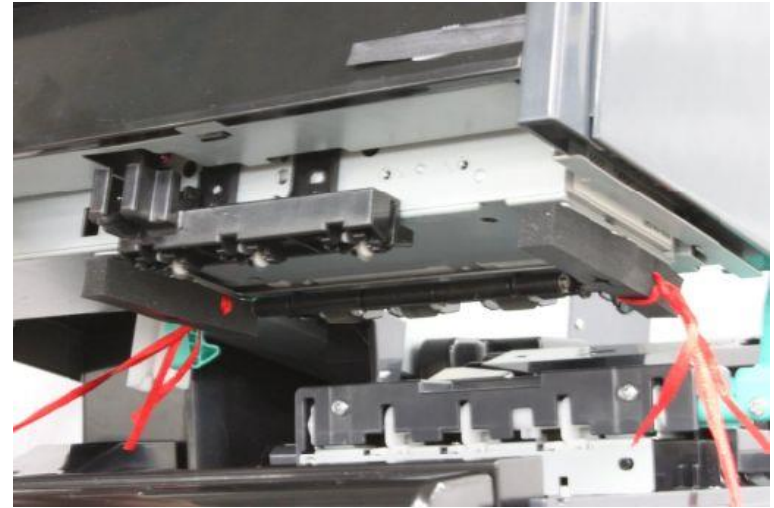
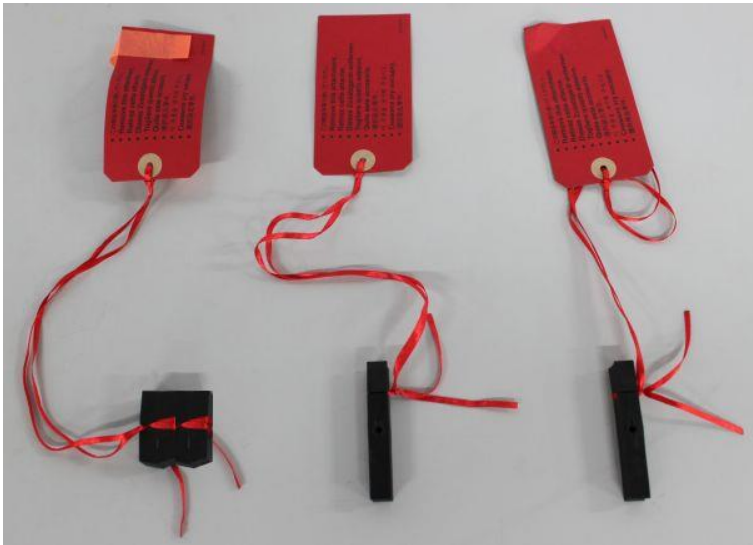

Preparation for Secondary Transportation - Normal

[Packing]

CAUTION:

Do not transport Printer with Ink Tanks.
Do not remove Maintenance Cartridge.

2. Wrap Printer with a plastic bag.
3. Attach pads and place Accessory Box on the upper pads.

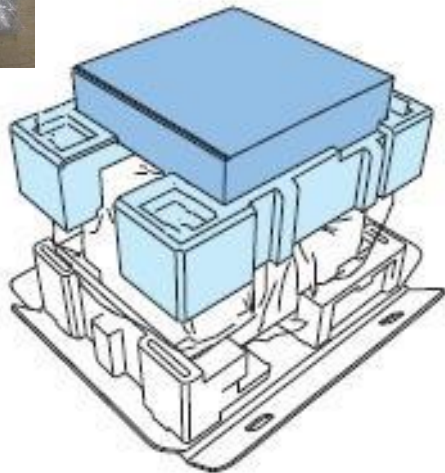

4. Put the upper box.
5. Attach grips (at 4 positions).



6. Completed package



For Telephone operator

1. What is difference of INKJET and Thermal Ribbon. (Advantage)
2. Overview of Swiftcolor product
3. General Q&A
4. Recommend Application
5. Price (List Price/Per Print Cost)
6. Durability (Machine/Media)
7. Maintenance
8. Setup
9. How to proceed shipping mode
- 10. How to use driver functions**
 - 1. Overlay Printing**
 2. Pinpoint color print
 3. Supplements
 4. Color matching

Please see manual

SCC-4000D: SCC-4000D USER'S GUIDE

SCC-2000D: SCC-2000D USER'S GUIDE

Overlay Printing Function

Contents

- What is the “Overlay” function?

- How to use the “Overlay” function
 1. Create a Form file (ofc. file)
 2. Overlay Printing

1. Create a Form file [.ofe]

- Open the file which you want to print as a background (fixed data)
- Then, execute a print job.

<Printing Image Example 1>

~fixed data only~



Case of Individual Turkey Pot Pies

Twombly Farms
Somerset, NJ 08873

Little Gobblers
Pie size: Small

Count: 8

7oz (196g) each

Nutrition Facts	
Serving Size 1 container (196 g) Servings Per Container 8	
Amount Per Serving	
Calories 200	Calories from Fat 100
% Daily Value*	
Total Fat 20g	37%
Saturated Fat 7.0g	14%
Trans Fat 0g	
Cholesterol 20mg	18%
Sodium 820mg	34%
Total Carbohydrate 26.0g	12%
Dietary Fiber 3.0g	12%
Sugars 3.0g	
Protein 11.0g	
Vitamin A 0%	Vitamin C 0%
Calcium 6%	Iron 0%

*Percent Daily Values are based on a diet of other people's misdeeds. Your daily intake may vary from the amount shown depending on your eating habits.

Calories: 200kcal / 200kcal

	Less than	65g	65g
Total Fat	Less than	65g	65g
Saturated Fat	Less than	20g	20g
Cholesterol	Less than	200mg	200mg
Sodium	Less than	2,400mg	2,400mg
Total Carbohydrate	Less than	25g	25g
Dietary Fiber	Less than	25g	25g

Contains 8 grams:

• Fat 9 • Carbohydrate 4 • Protein 4

Turkey Stock, Enriched Flour (Wheat Flour, Niacin, Ferrous Sulfate, Thiamine Mononitrate, Riboflavin, Folic Acid), Cooked Ground Turkey (Water, Salt, Soy Protein Isolate, Carrageenan, Modified Food Starch, Sodium Phosphate, Spice Extract), Shortening (Lard).

1. Create a Form file [.ofe]

- On “Overlay Setting” tab in printer driver, check the box of Overlay and select “Print the form to the file”.

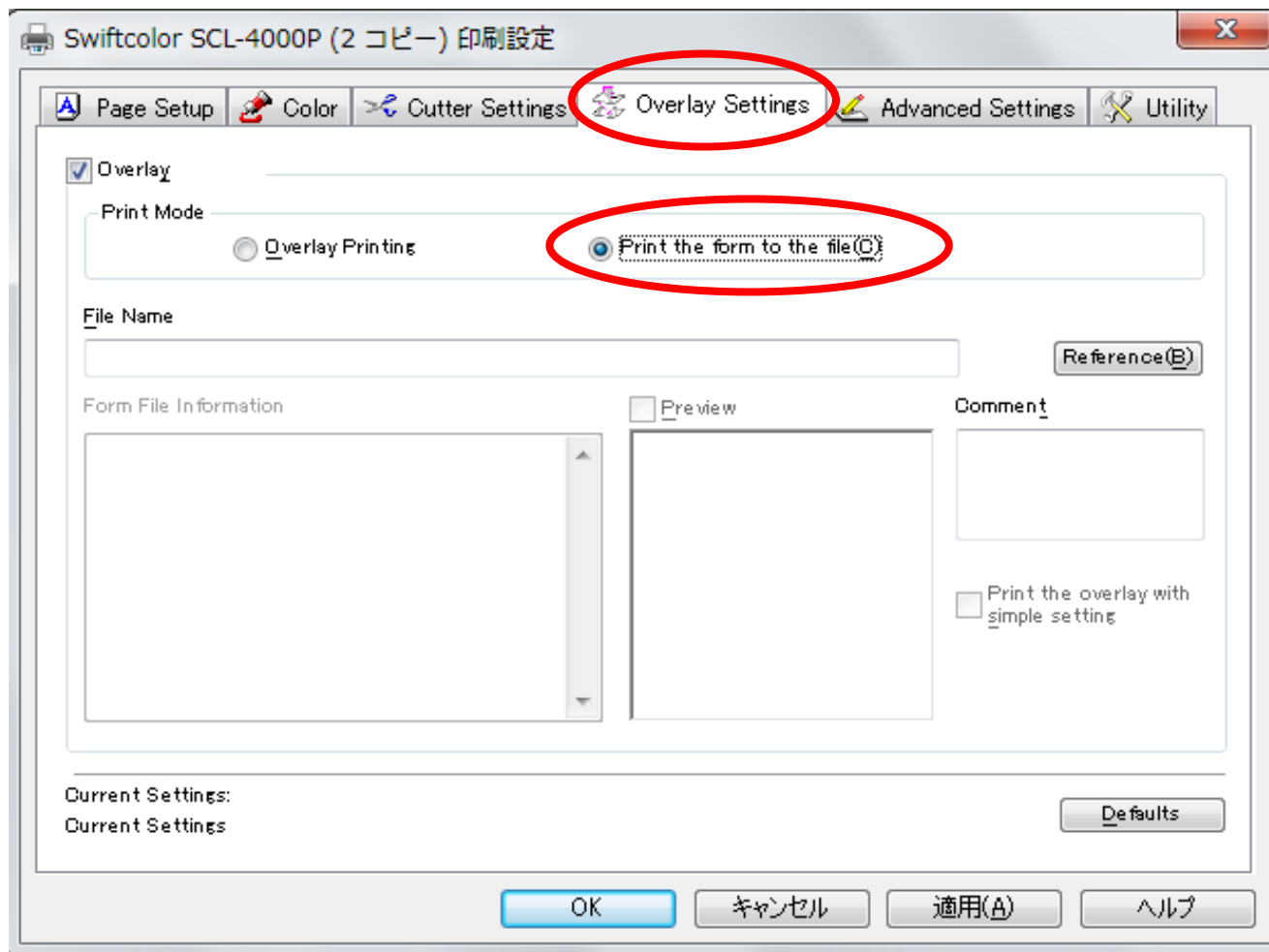

1. Create a Form file [.ofe]

- Decide “1. File Name” and “2. Where to save the [.ofe] file”
- Also, you can write “3. comment” in the box below.
- After set up is completed, click OK

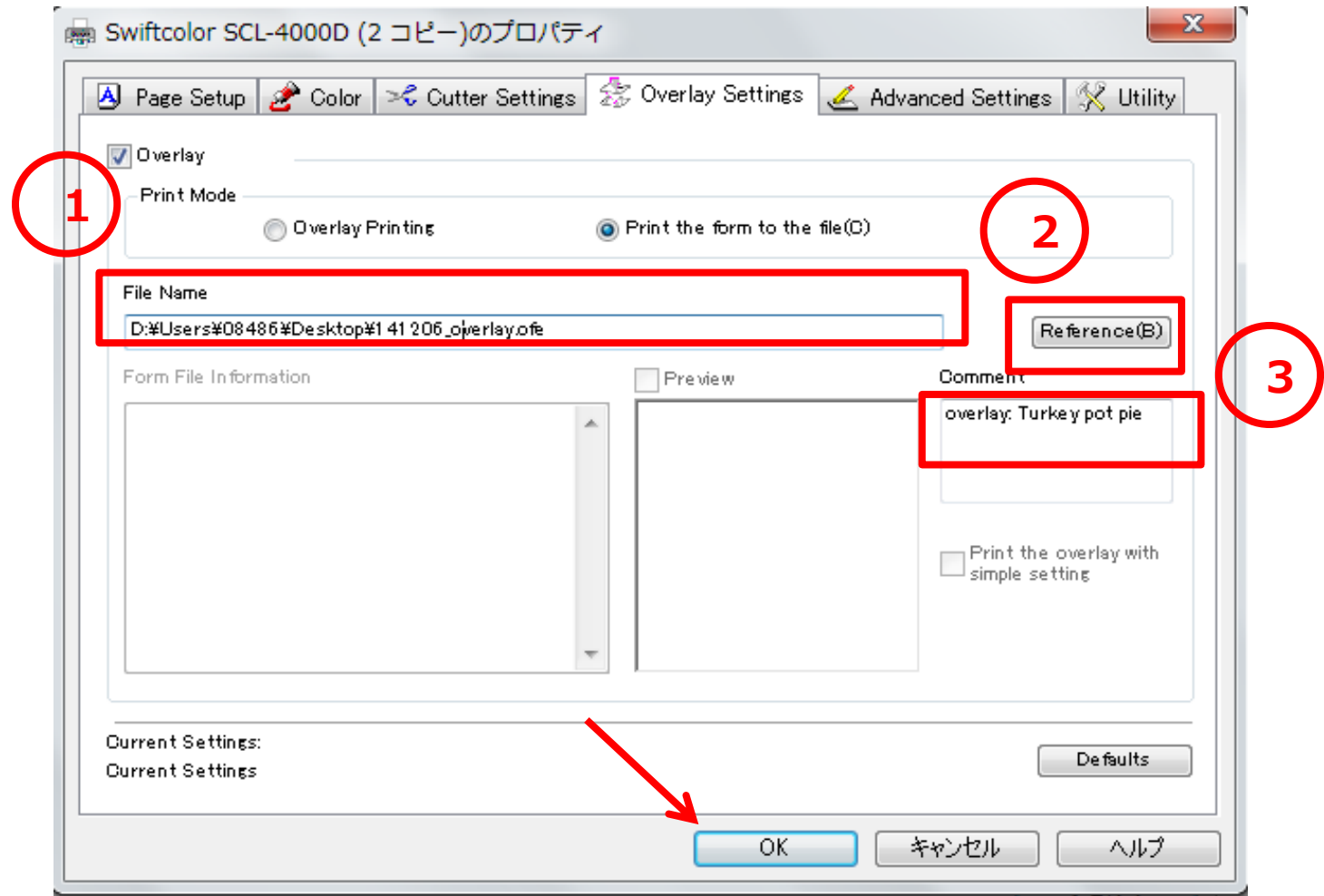

1. Create a Form file [.ofe]

- When the print execution window appears again, click [Print]. Print data will be used as a form file.
 - *Be sure to turn on the printer before executing print
- The data is saved in the folder created as a form file.

2. Overlay Printing

- Open the file which you want to print as a variable image.
- Then, execute a print job.

<Printing Image Example 2>
~variable data only~

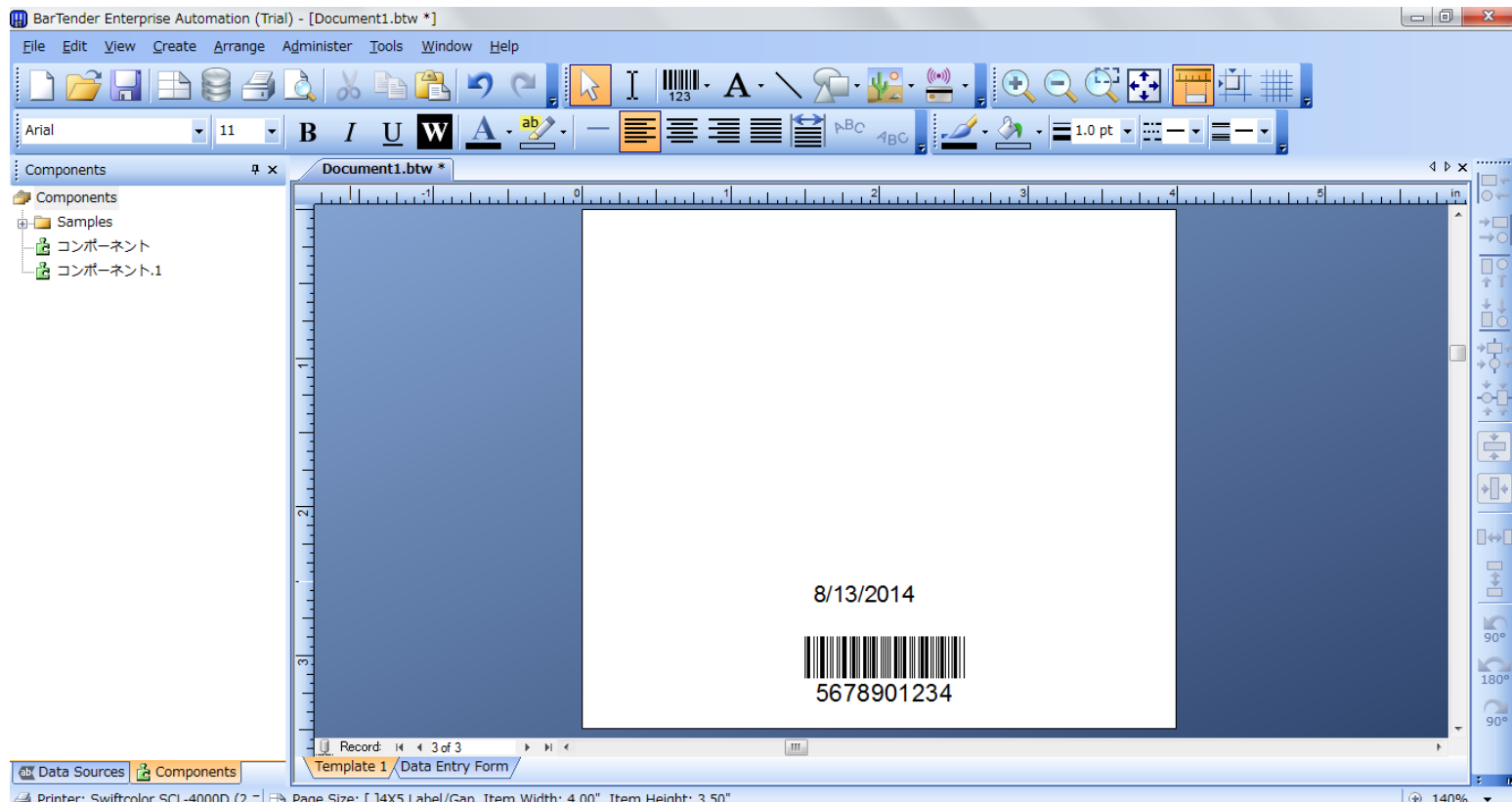

2. Overlay Printing

- On “Overlay Setting” tab in printer driver, check the box of Overlay and select “Overlay Printing”.

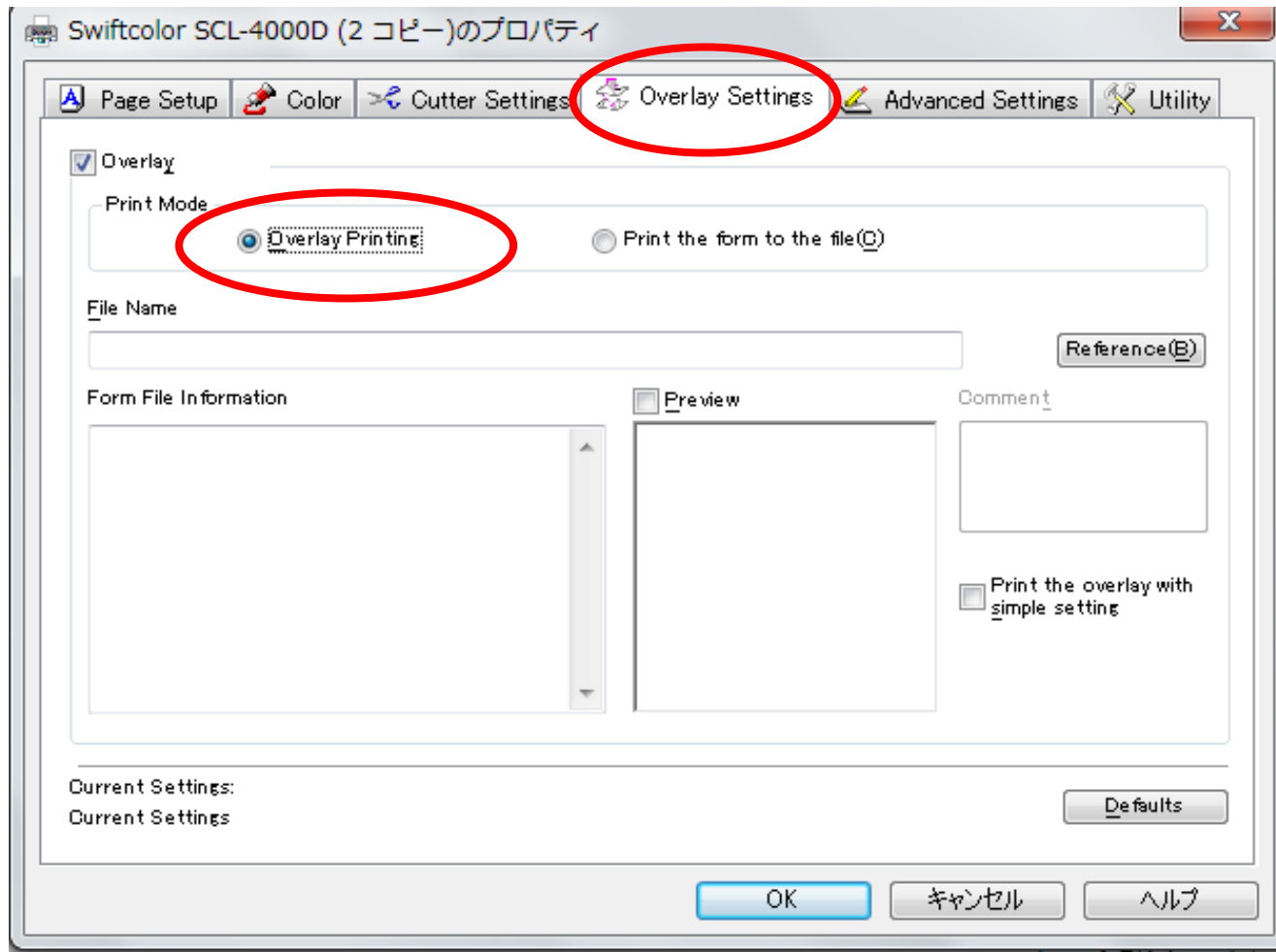

2. Overlay Printing

- Click Reference and choose the [.ofe] file you created.
- Check information in “1. Form File Information” and “2. Preview”.
- After set up is completed, click OK

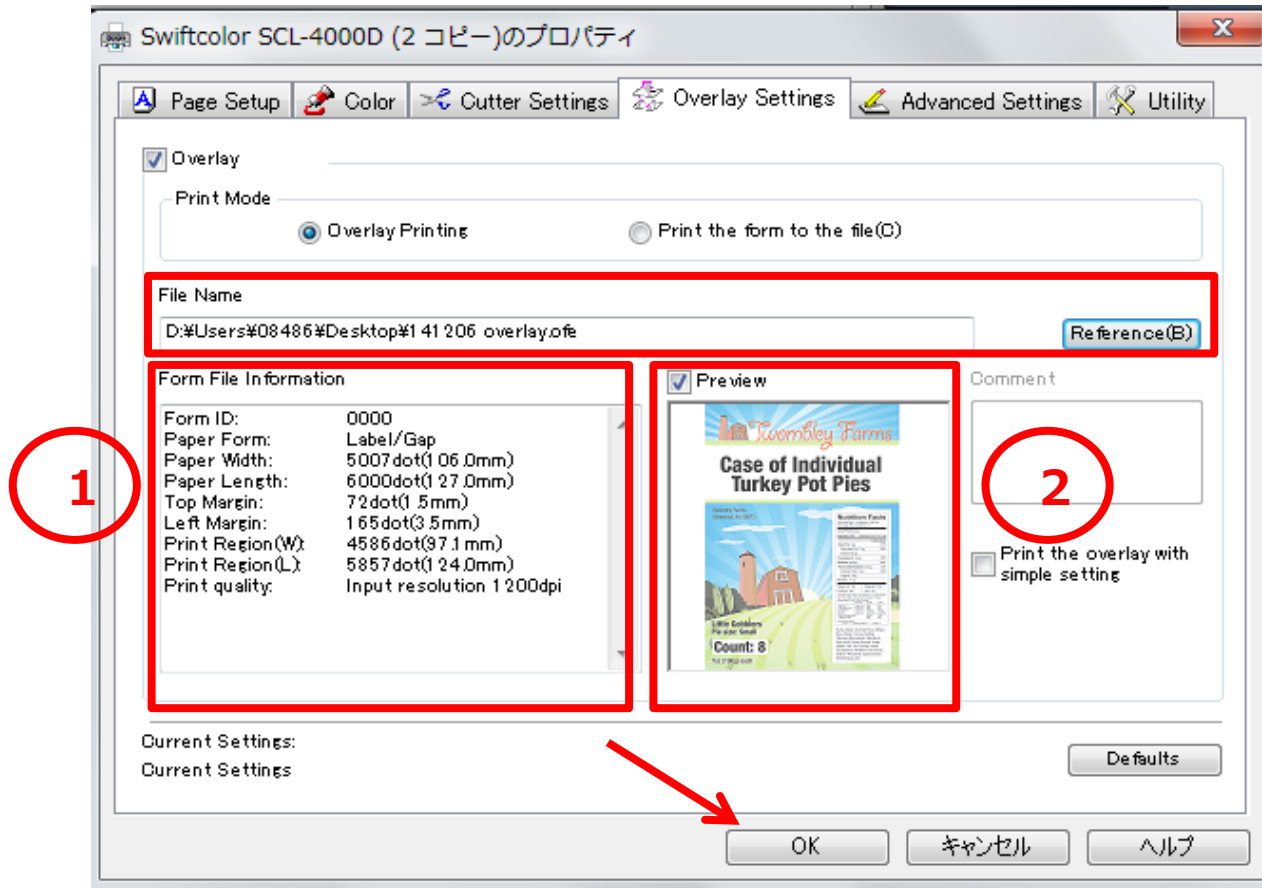

2. Overlay Printing

- Execute a print job.
- Print data is printed overlaid with the form file.

Note

- Overlay printing would be disabled if the print setup information differs between the print data and the form file.
- When a document is printed in single-color zebra, it can be overlaid with form data even if it varies in the number of colors.
- Overlay printing may not work if the printer driver with which the form has been created has an invalid version or the like. In this case, create a form file with the printer drive to be used for overlay printing.
- [Form File Information] or [Preview] may not be displayed depending on the form file.

For Telephone operator

1. What is difference of INKJET and Thermal Ribbon. (Advantage)
2. Overview of Swiftcolor product
3. General Q&A
4. Recommend Application
5. Price (List Price/Per Print Cost)
6. Durability (Machine/Media)
7. Maintenance
8. Setup
9. How to proceed shipping mode
- 10. How to use driver functions**
 1. Overlay Printing
 - 2. Pinpoint color print**
 3. Supplements
 4. Color matching

Pinpoint Color Matches

Contents

- 1. R/G/B value reading procedure (Paint)

- 2. Pinpoint Color Matches

1. R/G/B value reading procedure (Paint)

- Please open an image for color matching in “Paint.”

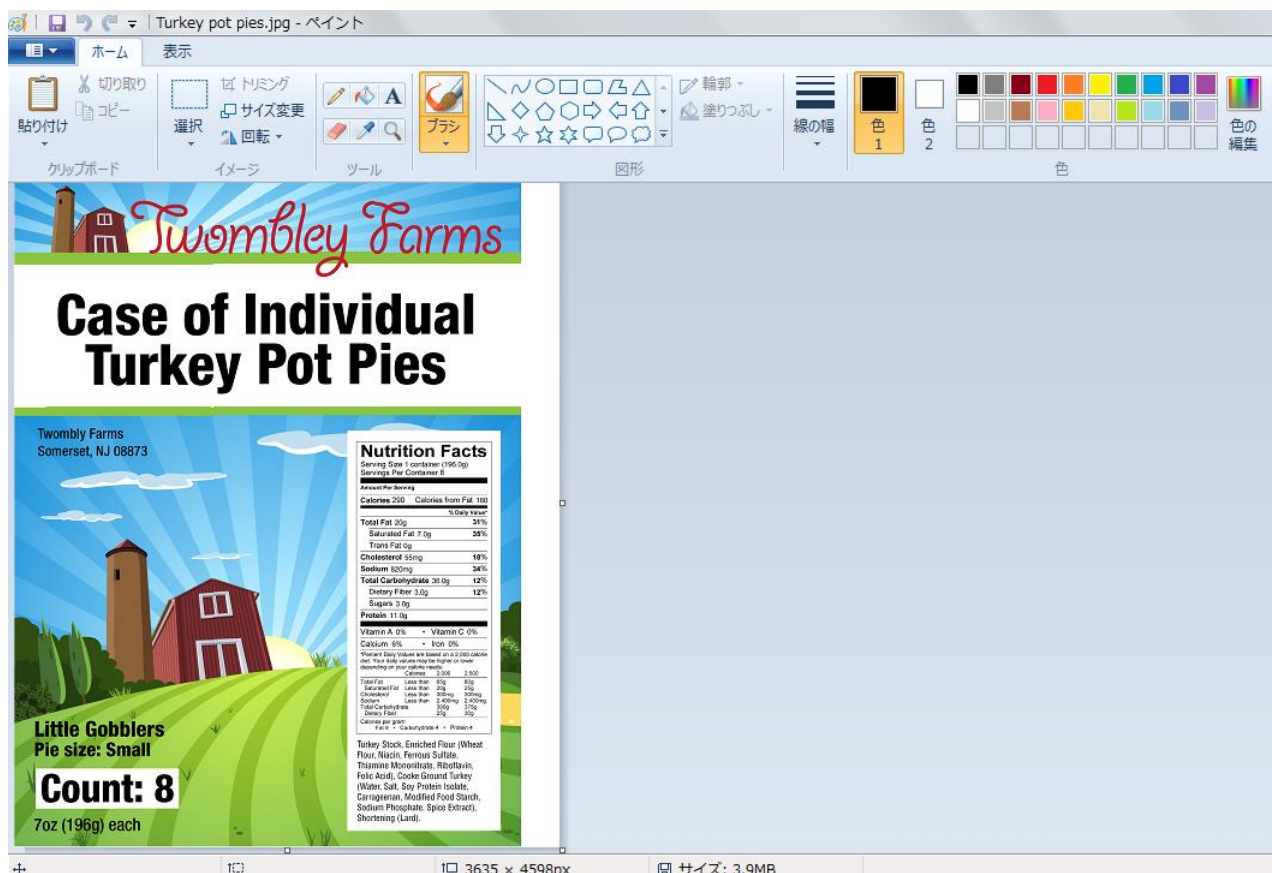

Note

- To read the R/G/B values from a source image that is subject to color matching, such as a logo mark, use an image processing program, such as “Paint,” which comes standard with Widows.

1. R/G/B value reading procedure (Paint)

- Please chose “Eyedropper” tool so that you can capture the color information of subject.

3. Click the image with the [Eyedropper] tool.

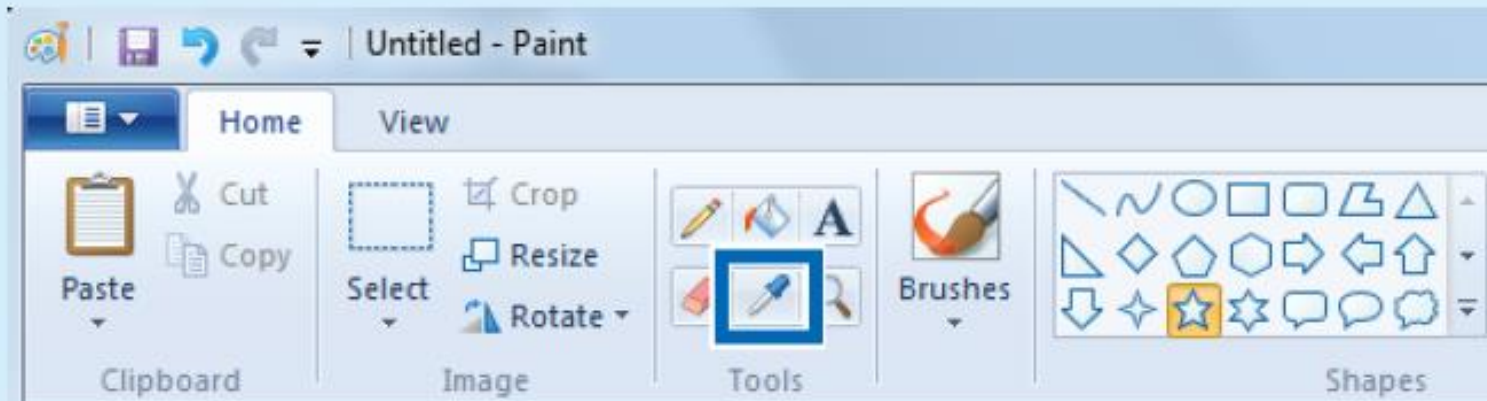

1. R/G/B value reading procedure (Paint)

- After you capture the color, please click “Edit Colors”

<For example, the letter (Twombly Farms) is captured for color match>

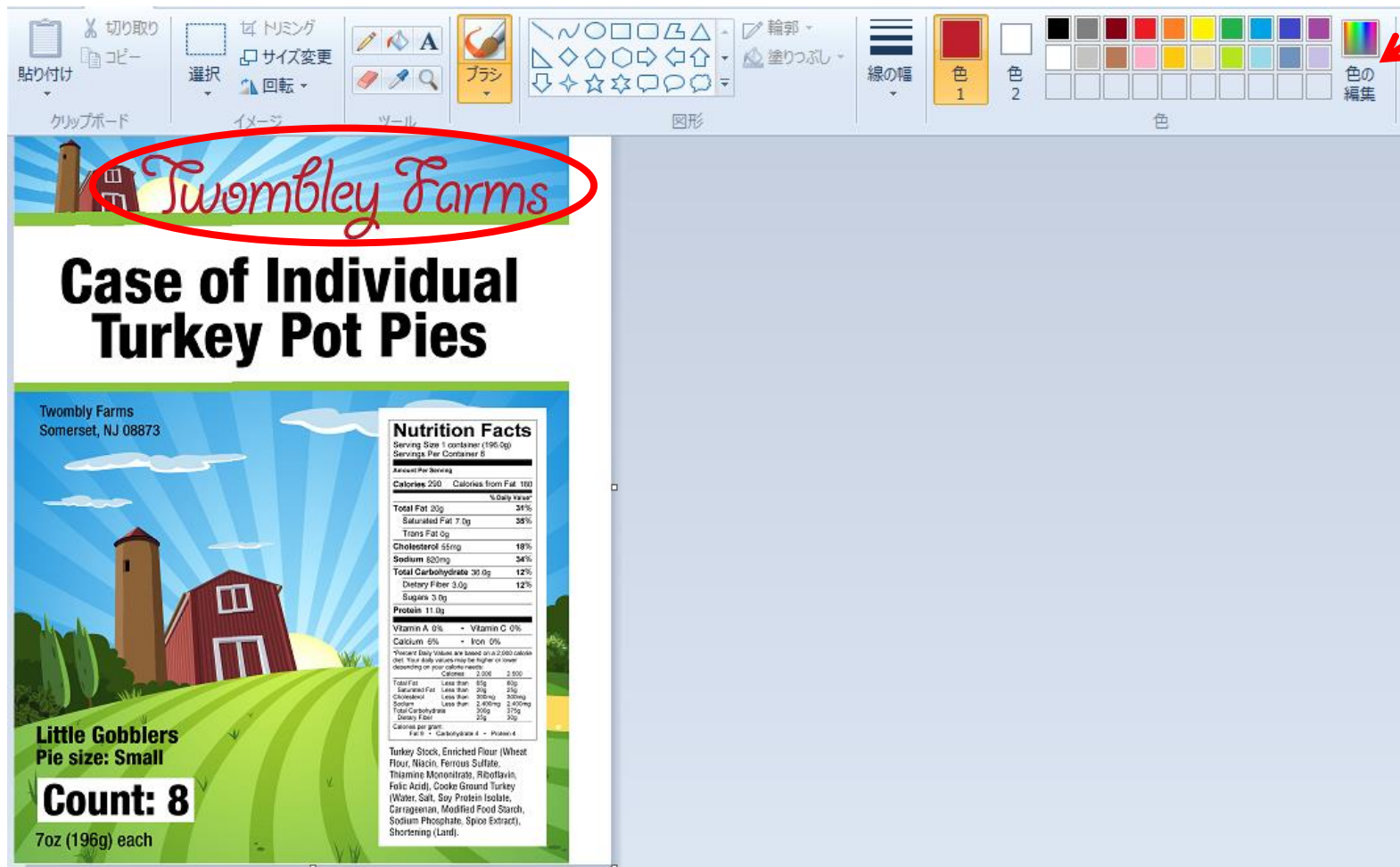

1. R/G/B value reading procedure (Paint)

- R/G/B value can be read as below

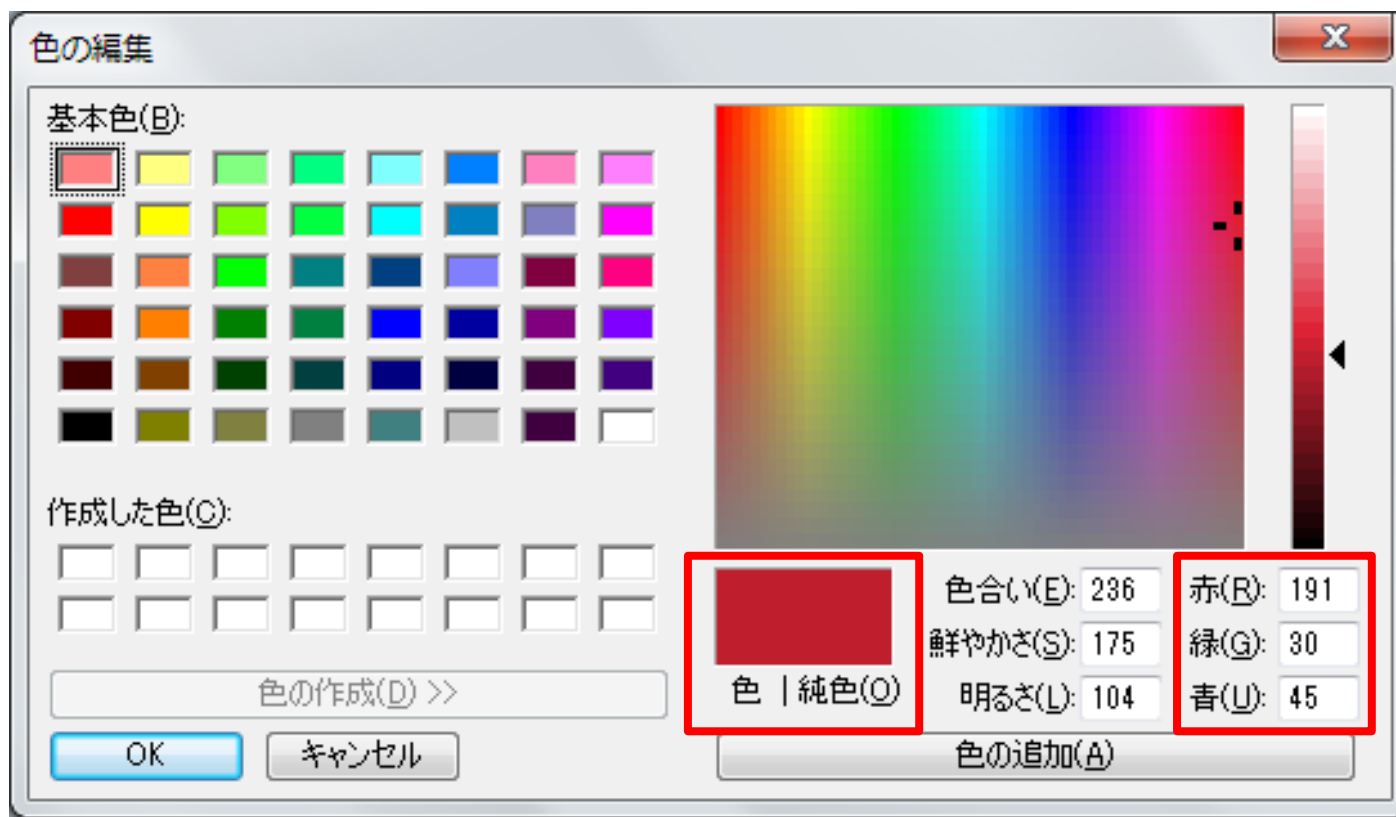

2. Pinpoint Color Matches

- Please click “Pinpoint Color Matches” from Utility.

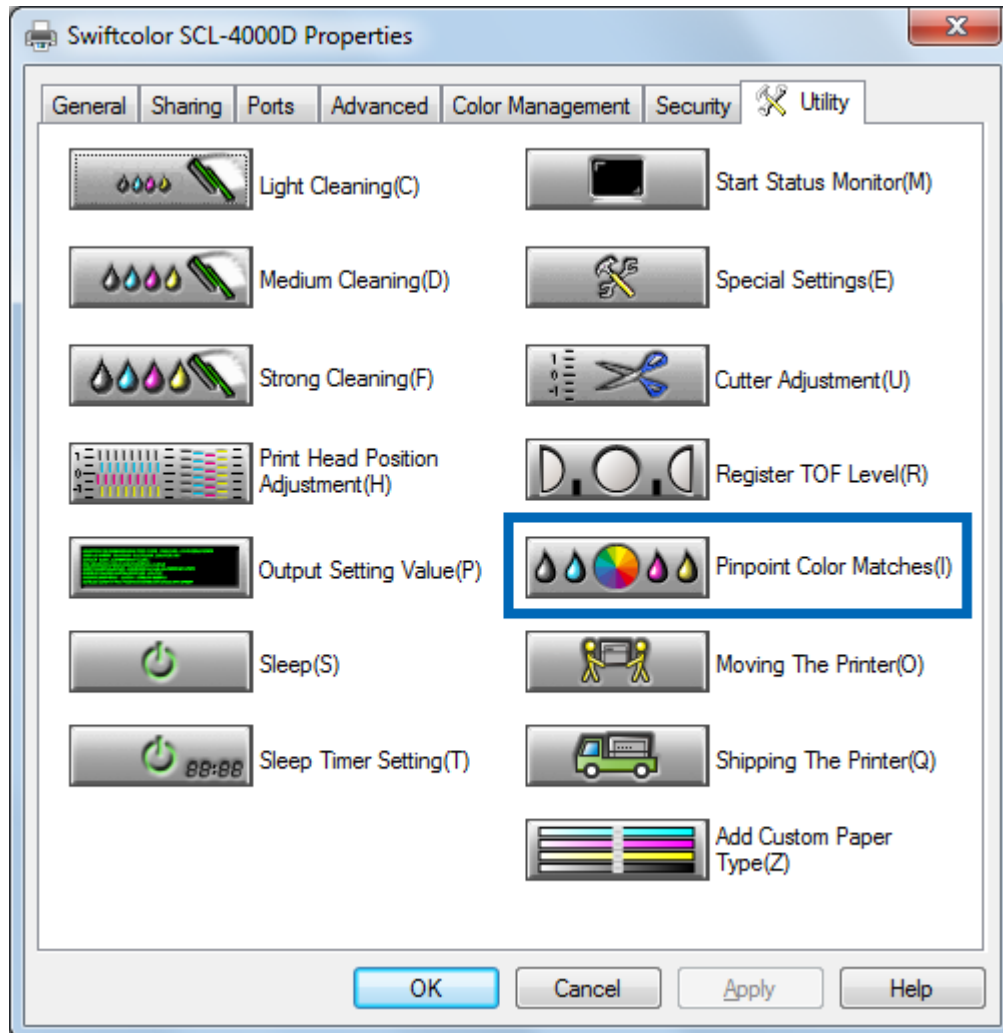

2. Pinpoint Color Matches

- “Pinpoint Color Matches” window appears
- After you read the values of R/G/B, please enter the read values into Red (R)/Green (G)/Blue (B) in the sheet.

Pinpoint Color Matches

Register special color.
Please set the color value (RGB) in the "Input Color" for the color you want to register as a special color.

Input Color

Red 246

Green 27

Blue 125

Check Pattern

Print Gradation 2 Gradation Number of Patterns 25 Amount of Change Normal Print

Reprint

If there are no desired colors inside the pattern, by reprinting using the closest color as the basis you can reprint with that color as the basis.

Standard Color 0 Select Pattern(J) RG Reprint(Y) Cancel

Register Special Color

Registered Color(F) 0 Comment Register

Register List

No.	Input Value	Output Value	Comment

Check Settings(M) Delete

Import Export Close(Q)

2. Pinpoint Color Matches

- Please print 25 square color pallets to designate color samples that represent approximate values 0 to 24.

Pinpoint Color Matches

Register special color.
Please set the color value (RGB) in the "Input Color" for the color you want to register as a special color.

Input Color

Red: 246
Green: 27
Blue: 125

Check Pattern

Print Gradation: 2 | Gradation Number of Patterns: 25 | Amount of Change: Normal | Print

Reprint

If there are no desired colors inside the pattern, by reprinting using the closest color as the basis you can reprint with that color as the basis.

Standard Color: 0 | Select Pattern(J): RG | Reprint(V) | Cancel

Register Special Color

Registered Color(E): 0 | Comment: | Register

Register List

No.	Input Value	Output Value	Comment

Check Settings(M) | Delete

Import | Export | Close(Q)

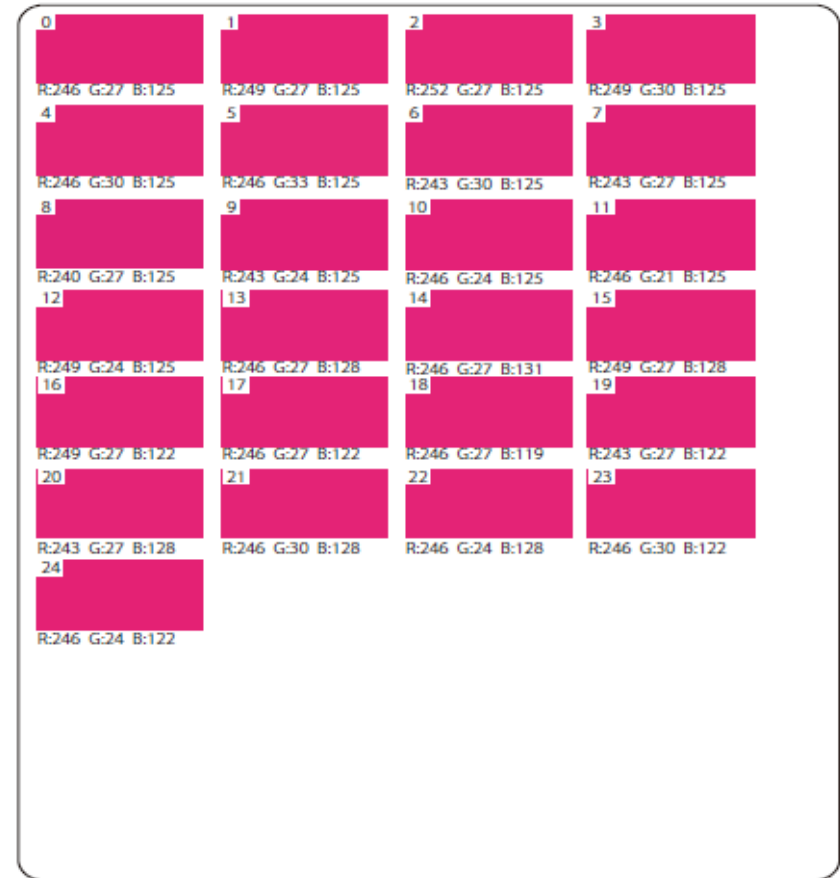

2. Pinpoint Color Matches

- If the target color is not found, create a color close to it by performing “Reprint”.
- Enter the number of the color closest to the target color in “Base Color”.

The screenshot shows a software interface for color management. At the top, there are input fields for Red (246), Green (27), and Blue (125), along with sliders and a color preview box showing a magenta color. Below this is a 'Check Pattern' section with dropdowns for 'Print Gradation' (set to 2), 'Gradation Number of Patterns' (set to 25), and 'Amount of Change' (set to Normal), and a 'Print' button. A 'Reprint' dialog box is open, highlighted with a blue border. It contains the text: 'Reprint. If there are no desired colors inside the pattern, by reprinting using the closest color as the basis you can reprint with that color as the basis.' Below the text are fields for 'Standard Color' (set to 0), 'Select Pattern(J)' (a dropdown menu currently showing 'RG' with a list of options: RG, GB, RB, R Expansion, G Expansion, B Expansion), a 'Reprint(V)' button, and a 'Cancel' button. Below the dialog box is a 'Register Special Color' section with a 'Registered Color(F)' field (set to 0), a 'Comment' field, and a 'Register' button. At the bottom, there is a 'Register List' table with columns for 'No.', 'Input Value', 'Output Value', and 'Comment'.

No.	Input Value	Output Value	Comment
-----	-------------	--------------	---------

2. Pinpoint Color Matches

- Select a color pattern in “Pattern Selection”.
- Select a color pattern by determining which of RGB needs to be enhanced with regard to the target color.

RG	Change the values of 2 colors, Red and Green, but not Blue.
GB	Change the values of 2 colors, Green and Blue, but not Red.
RB	Change the values of 2 colors, Red and Blue, but not Green.
R Expansion	Change the values of 3 colors across the board and then increase or decrease the value of Red.
G Expansion	Change the values of 3 colors across the board and then increase or decrease the value of Green.
B Expansion	Change the values of 3 colors across the board and then increase or decrease the value of Blue.

2. Pinpoint Color Matches

- If the target color is found in the color samples printed, select a number in [Registered Color] among 0 to 24
- Please enter any name in the "Comment" field and click "Register".

Pinpoint Color Matches

Register special color.
Please set the color value for the "Input Color" for the color you want to register as a special color.

Input Color

Red 240

Green 27

Blue 125

Check Pattern

Print Gradation 2

Number of Patterns 25 Amount of Change Normal Print

Reprint

If there are no desired colors in the pattern, by reprinting using the closest color as the basis you can reprint with the pattern.

Standard Color 0

Select Pattern(J) RG Reprint(V) Cancel

Registered Color(E) 0 Comment Register

Register List

No.	Input Value	Output Value	Comment

Check Settings(M) Delete

Import Export Close(O)

2. Pinpoint Color Matches

- The registered color will be displayed in the “Register List.”

Register special color.
Please set the color value (RGB) in the "Input Color" for the color you want to register as a special color.

Input Color

Red: 240
Green: 27
Blue: 125

Check Pattern

Print Gradation: 2
Gradation Number of Patterns: 25
Amount of Change: Normal

Reprint

If there are no desired colors inside the pattern, by reprinting using the closest color as the basis you can reprint with that color as the basis.

Standard Color: 0
Select Pattern(J): RG

Register Special Color

Registered Color(E): 0
Comment: Label-07

No.	Input Value	Output Value	Comment
1	R:240 G:27 B:125	R:240 G:27 B:125	Label-07

2. Pinpoint Color Matches

- To check to see if a color has been registered or not, click “Printing Preferences” → “Color” → “Set Pinpoint Color Matches” and view “List of registered color”.

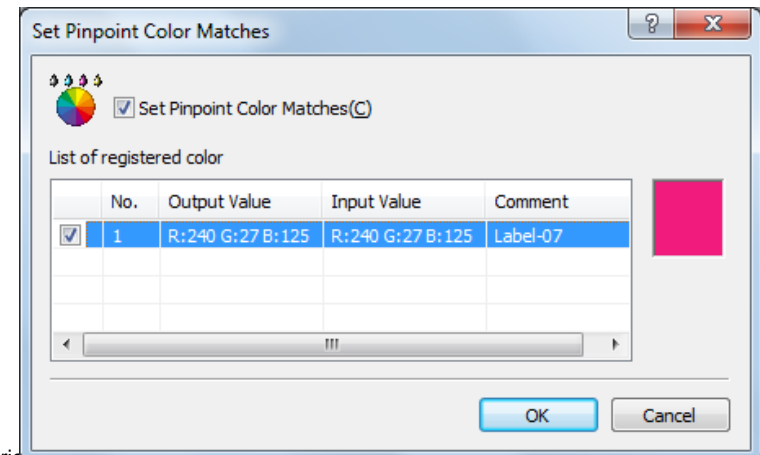
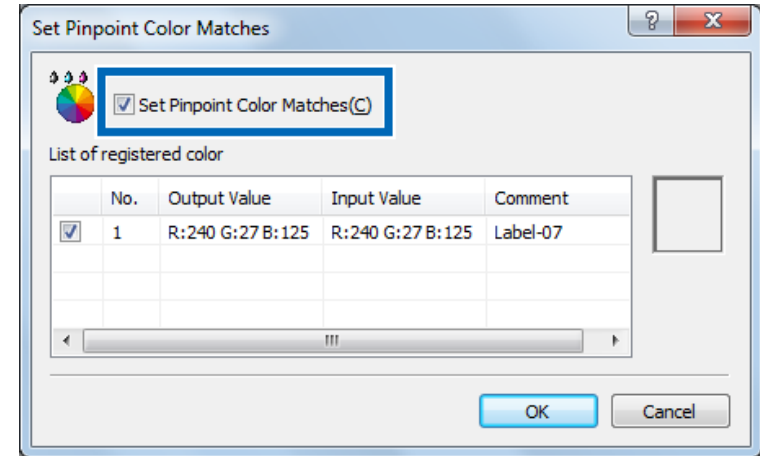
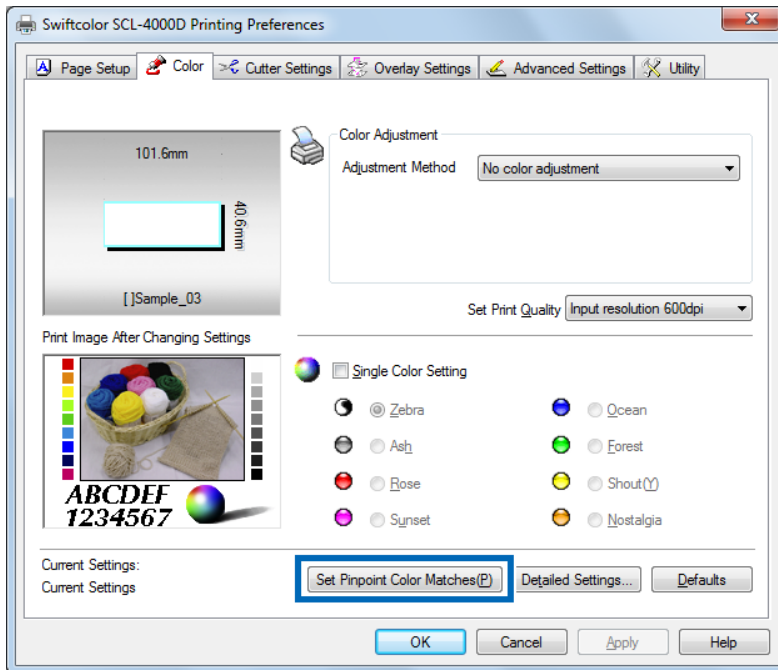

For Telephone operator

1. What is difference of INKJET and Thermal Ribbon. (Advantage)
2. Overview of Swiftcolor product
3. General Q&A
4. Recommend Application
5. Price (List Price/Per Print Cost)
6. Durability (Machine/Media)
7. Maintenance
8. Setup
9. How to proceed shipping mode
- 10. How to use driver functions**
 1. Overlay Printing
 2. Pinpoint color print
 - 3. Supplements**
 4. Color matching

SCC Driver “Supplements”

1. Keynotes

1. Adjusting color: There are several ways to adjust color using SCC driver setting as below.

1. Change paper type

SCC driver has 5 different paper type as default. By changing the paper type, color profile and Ink jetting amount will be changed as below.

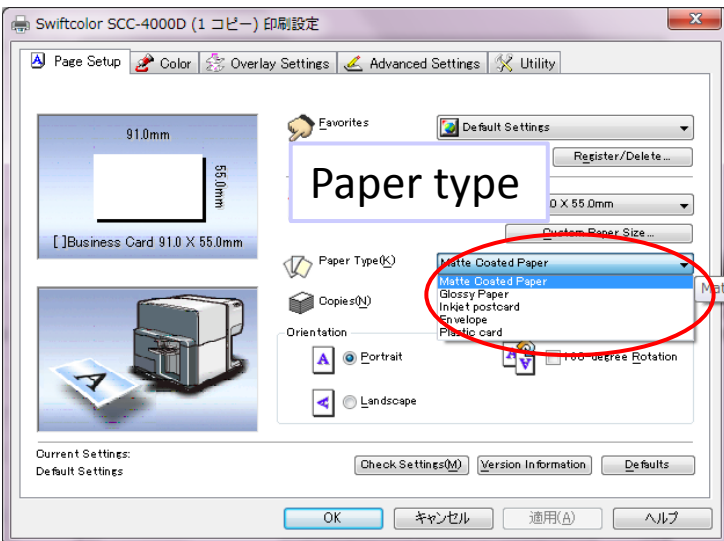

Used Color profile	Paper Type	Note
Color profile 1	Matte Coated Paper Envelop Inkjet post card	Ink jetting amount differs for each media type.
Color profile 2	Glossy Paper	
Color profile 3	Plastic card	

Note: Ink jetting amount for each paper type can be checked at “ Add custom paper type” in Printer driver utility tab.

Advanced: “Add custom paper type”- Change ink jetting amount for your own media and improve print result even more. - Refer to P. 5 for description.

SCC Driver “Supplements”

1. Keynotes

1. Adjusting color: There are several ways to adjust color using SCC driver setting as below.
2. Change Adjustment Method in Color tab
 SCC driver has 2 adjustment method as default (exclude Use ICM).
 >>#1, #2; In total there are 6 color difference as below (right figure).

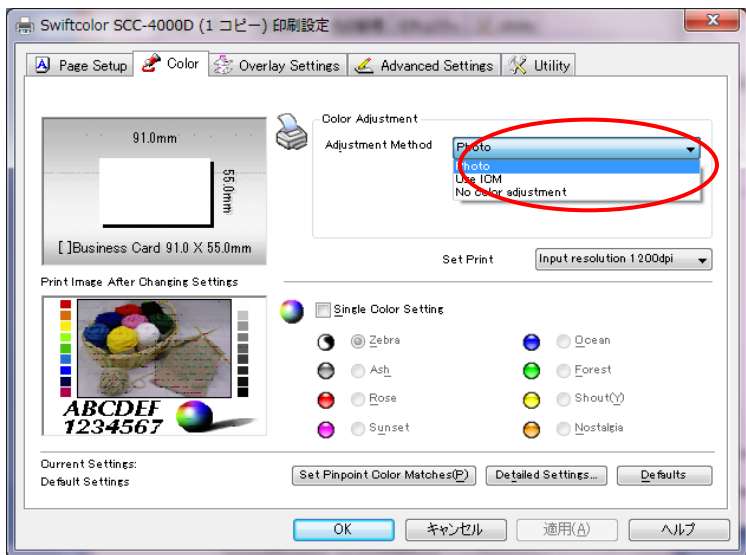

Adjustment Method	Paper Type	Used Color profile	
Photo	Matte Coated Paper, Envelop, Inkjet post card	Color profile 1	1
	Glossy Paper	Color profile 2	2
	Plastic card	Color profile 3	3
No color adjustment	Matte Coated Paper, Envelop, Inkjet post card	Color profile 1	4
	Glossy Paper	Color profile 2	5
	Plastic card	Color profile 3	6
Use ICM	Above color profile of CFT driver will be invalid		

Advanced: In case using your own ICM refer to p.9 and select Use ICM.

SCC Driver “Supplements”

1. Keynotes

1. Adjusting color: There are several ways to adjust color using SCC driver setting as below.
3. Detailed Settings function
 By changing Detailed Setting the entire print image will be influenced >> Suitable for adjusting photo or whole design image color.
 Color shift image by adjusting each setting is shown in the next page.
 **In case you want to adjust particular color only, use Pin point color matches. >> Suitable for adjusting Company logo color etc.

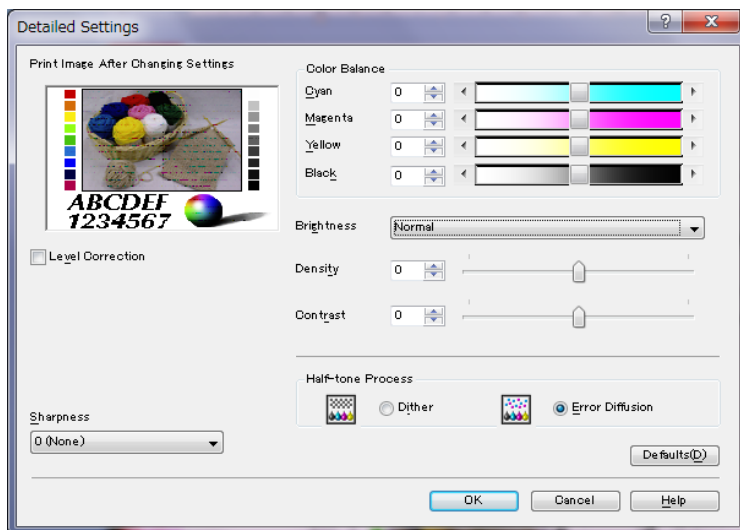

SCC Driver “Supplements”

1. Keynotes

2. Print head position and media ejection lever position difference
 1. Print head position and media ejection lever position differs according to the selected “Paper Type” and “Paper Form”.

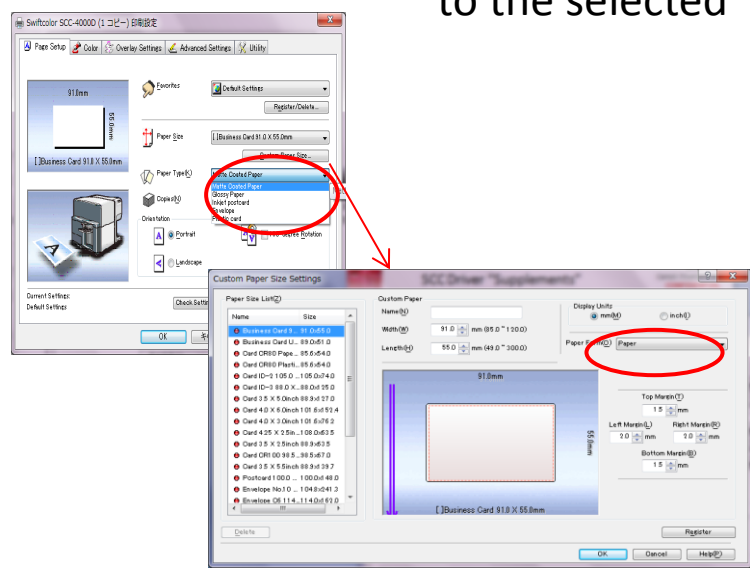

Driver Setting		Printer Setting	
Paper Type	Paper Form	Print head position	Thick paper transport lever
Matte Coated Paper	Paper	A	
	Thick Paper	B	
	Envelope	E	
	Card(20-30mil)	D	1
Envelope	Paper	E	
	Thick Paper		
	Envelope		
Glossy Paper	Card(20-30mil)	D	1
	Paper		
	Thick Paper		
	Envelope		
Inkjet postcard	Card(20-30mil)	A	
	Thick Paper		
	Envelope		
	Paper		
Plastic card	Card(20-30mil)	C	1
	Thick Paper		
	Envelope		
	Paper		

Note: Print head position: A----> E (print head position gets higher; Media Thin ----> Thick). May cause paper jam in case proper setting is not selected.

Thick paper transport lever (UG p.23): Pull out (1) for using Plastic and Card (20-30mil) media.* **Caution: Lever should be at the normal position when “Plastic card” is selected and media length is longer than 65mm. Error occurs “Thick feed lever position error” depending on the selected paper type and form.**

SCC Driver “Supplements”

1. Keynotes

Utilize!: Combination with Keynote #1 and #2

*Please be aware of Keynote #1 and #2 when adding your own custom paper size.

*If you desire to use Color profile1 with plastic card media, select “Matte coated paper” and “Card(20-30mil).”

*If you desire to use Color profile 3 (plastic card) for either normal matte or glossy media , select “Plastic card” and “Thick Paper”.

Used Color profile	Paper Type
Color profile 1	Matte Coated Paper Envelop Inkjet post card
Color profile 2	Glossy Paper
Color profile 3	Plastic card

Driver Setting		Printer Setting	
Paper Type	Paper Form	Print head position	Media ejection lever
Matte Coated Paper	Paper	A	
	Thick Paper	B	
	Envelope	E	
	Card(20-30mil)	D	1
Envelope	Paper	E	
	Thick Paper		
	Envelope		
	Card(20-30mil)		
Glossy Paper	Paper	A	
	Thick Paper	B	
	Envelope	E	
	Card(20-30mil)	D	1
Inkjet postcard	Paper	A	
	Thick Paper		
	Envelope		
	Card(20-30mil)		
Plastic card	Paper	C	1
	Thick Paper	B	
	Envelope	E	
	Card(20-30mil)	C	1

SCC Driver “Supplements”

1. Keynotes

- 4. Registered paper form for each default paper size
 - 1. Can be checked in custom paper size dialog
- Choose desired paper type and check Paper Form

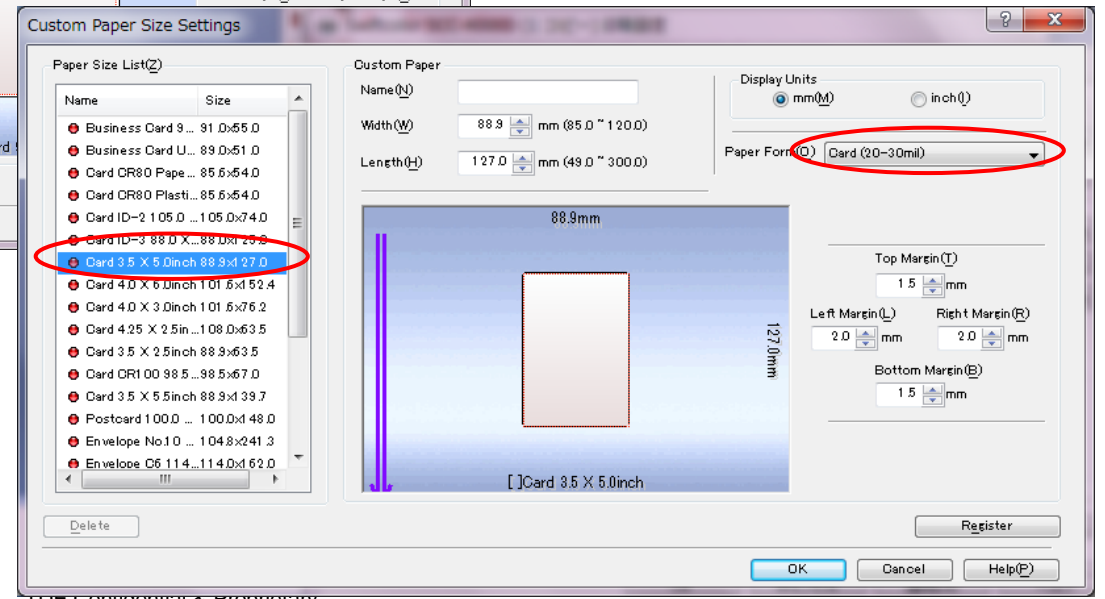
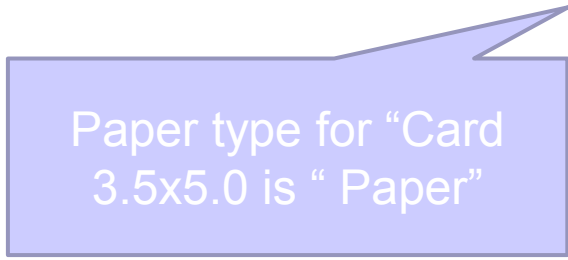
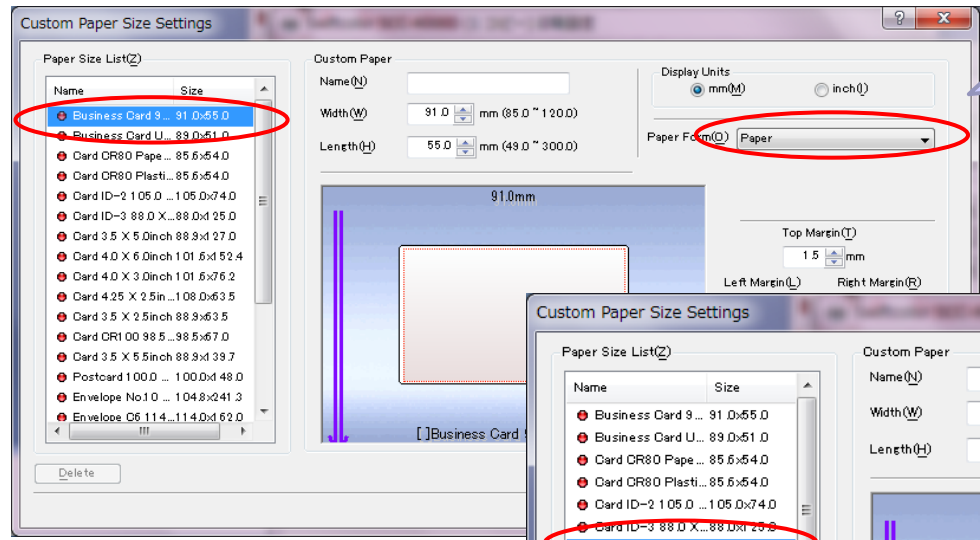

SCC Driver “Supplements”

1. Keynotes

5. To print plastic card
 1. Follow the direction in UG p.24-
 2. Caution: **Press Pause after changing Feeder tray lever position(UG p.25)** . **If not, even you send the data, the printer do not start printing.**
Below Error state will be shown in the PC.

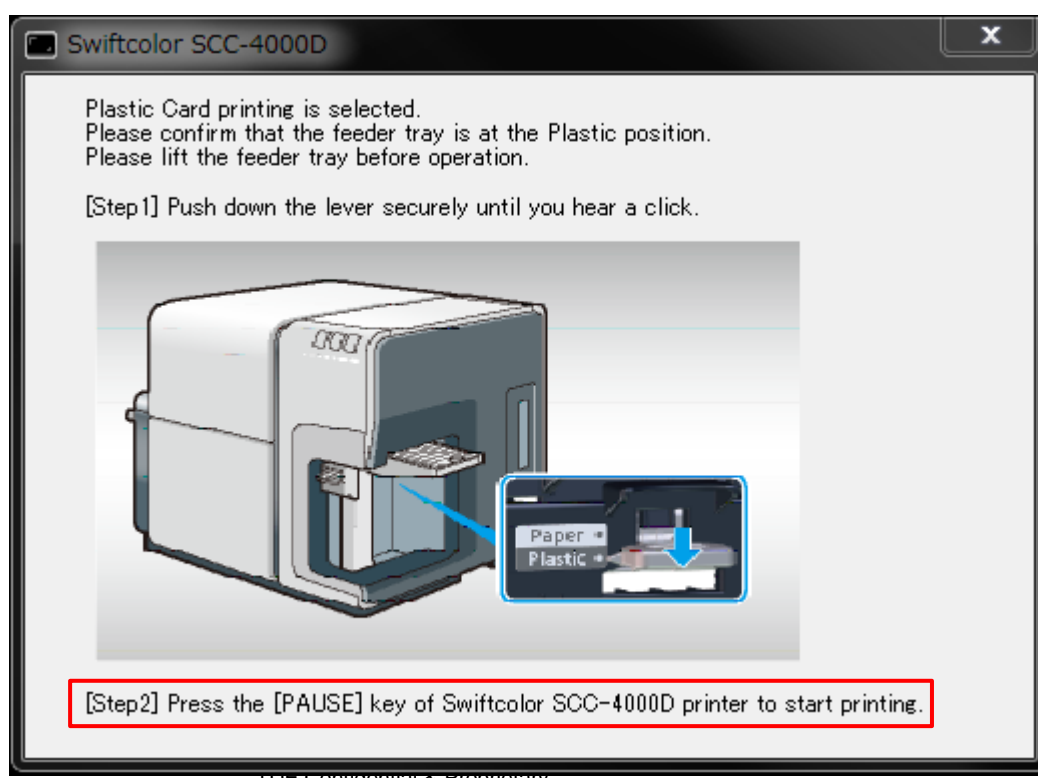

SCC Driver “Supplements”

2. ICM profile (Color reproducibility)

1. Delete ICM file; SCC-4000D

- Please delete the dummy file before use.

Open Device and Printer>Select Swiftcolor SCC-4000D> Click Printer Property>

1. Select Color Management tab>2. Open Color Management>

3. Check Use your own setting with this Device> 4. Select Profile (Manual)> 5. Delete CG440CC

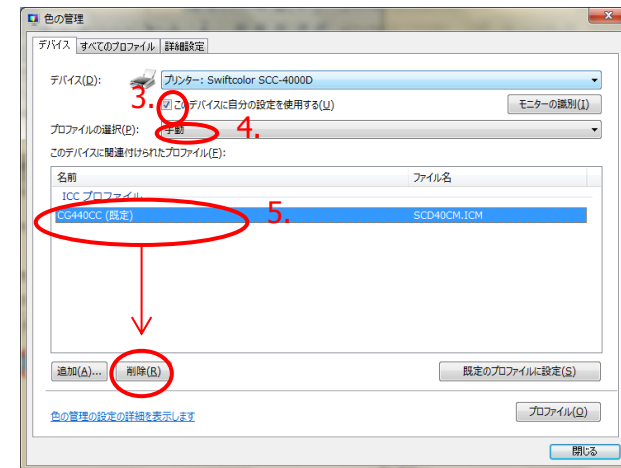
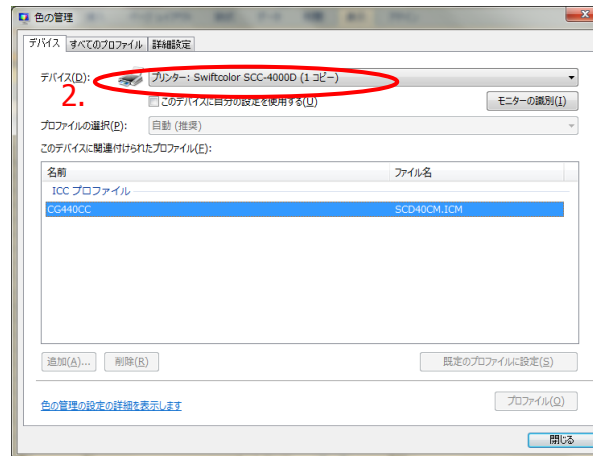
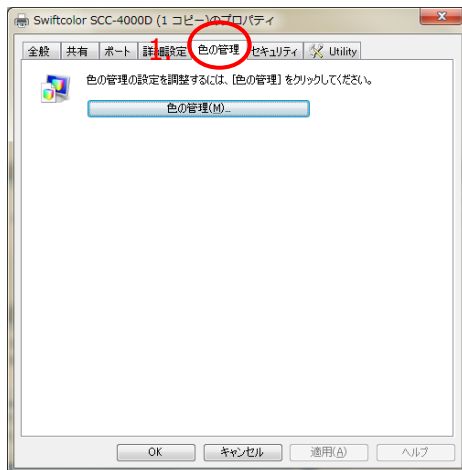

Note:

- Please check above points when there is an inquiry for color reproducibility
- If you want to use your own ICM profile, please add your own ICM profile to above printer property and **select Use ICM at printer driver.**
- Cautions: Depending on applications, some applications validate ICM profile as default setting (ignores driver setting). > Refer to Application “Supplements”

SCC Driver “Supplements”

3. Utility functions difference

1. Printer Driver Utility; Maintenance function for operator
 2. Printer Property Utility tab; Adjustment functions for administrator
1. Printer Driver Utility 2. Printer Property Utility tab

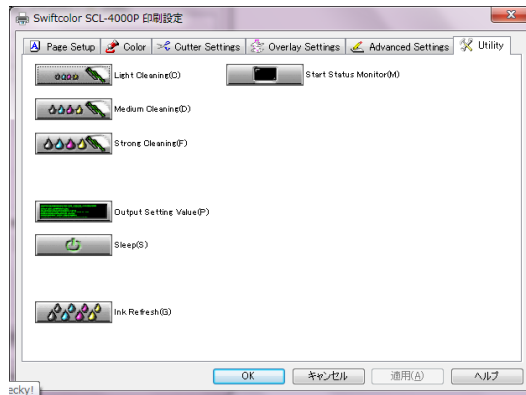

Cautions for changing driver setting:

1. Settings changed via Printer Driver Utility tab which is opened from applications will not be saved. It is valid only within the active application.
2. By setting via Printer property Utility tab, printer driver remembers the setting. Thus, changed setting will be reflected to all data in the same PC.

SCC Driver “Supplements”

4. Remarks – to be fixed

1. Default paper name missing in applications: SCC driver default paper name may not appear properly when selecting paper size from the application side.
*Add Screen shot: Ex. photo viewer
→Occurs when paper name is longer than 32 words
2. Custom paper setting: Inch setting cannot be used when registering custom media size
→Only “mm” is valid for use to register media as custom paper setting.
[Tentative counter measure]
Please convert into “mm” and register.

SCC Driver “Supplements”

4. Remarks – to be fixed

3. Applications: When particular Applications and Office applications are used, when printing media whose width is longer than the length, printed image may be defected.

→ Some of Microsoft Office applications defines that the media is always vertically long. However, SCC-4000D has horizontally long media (i.e. business card). In case, when it receives horizontally long media, it automatically convert the data as horizontally long data and print, resulting in image defect.

Example:

Sent data: image is intended to print as below.

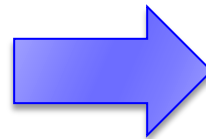
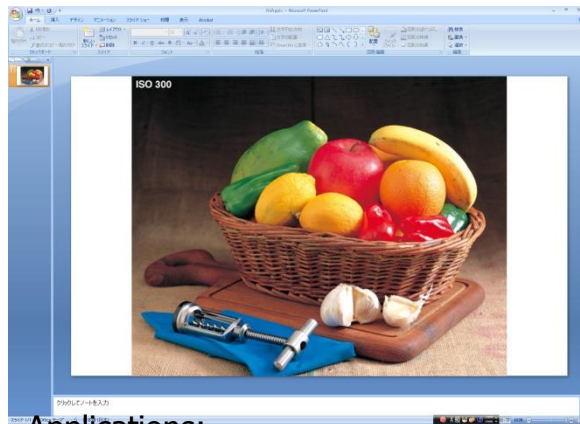

Printed image: image is printed as if the media is vertically long.



Applications:

Office; Power point, word 2010, 2013 and Other application which follows office media definition such as Card Exchange etc.

For Telephone operator

1. What is difference of INKJET and Thermal Ribbon. (Advantage)
2. Overview of Swiftcolor product
3. General Q&A
4. Recommend Application
5. Price (List Price/Per Print Cost)
6. Durability (Machine/Media)
7. Maintenance
8. Setup
9. How to proceed shipping mode
10. How to use driver functions
 1. Overlay Printing
 2. Pinpoint color print
 3. Supplements
 4. **Color matching**

How to match color by Swift Color Printer

Basic instruction for color matching

- Be sure to use “RGB value” (not CMYK value) when you change the color.
(If using CMYK value, narrow color gamut may be narrow than original one compared with using RGB value(It depends on software that you are using)).
- Be sure to use same media which are used practically for color matching.
- Be sure to settled driver setting (color adjustment mode, paper type).
- There is no automatic system or settled setting corresponding color guide (ex. PANTONE). You need to find approximated color manually.
- Please kindly switch off “color management” when print a data by illustrator or photoshop directly.

Steps for color matching

① Print color chart by using same media and same driver setting



⇒ Media and driver setting should be used same ones of practical use. If not, print result will be different.

② Find and pick up similar color patch among the color chart.



⇒ Pick up several (if needed).

③ Set the RGB value that you picked up and print it. Compare the color between it and Color reference (ex. PANTONE).

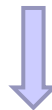

⇒ The color will be changing soon after printing and printing after a few minutes. Shake media a little after printing and wait a minute. After that, compare with both 2 colors.

④ Adjust the color by changing RGB value from 3 ~15 points with reference of changing trend of color chart.



Adjust by trial and error with reference to “points of RGB value setting”

⑤ Print it again with adjusted RGB value, and compare with color reference.



• Fixed (or return and repeat ④~⑤ steps if the color is still different)

Point of RGB value setting①

- Even you change RGB value at same rate, color won't change at same rate. Some color gamut changes sensitively with a few change rate, but another is not. Knowing point below helps you to do color matching smoothly.

【the case: 3 RGB values is near with each other】

In the case of RGB values is near each other(Ex. gray), the color will change significantly with a few change. **Adjust RGB value bit by bit (ex. each by 3 or 4).**



【Turning point of color changing】

Green⇒Blue, red⇒pink, red ⇒orange, on the turning point of color, a few change makes a big difference. **Adjust RGB value carefully (ex. each by 6 or 7).**

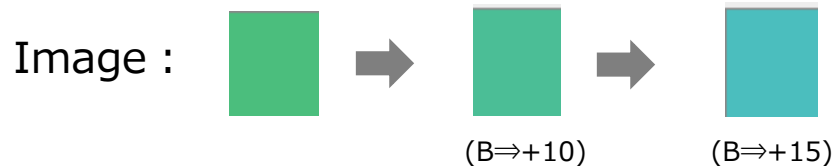

⇒Pinpoint color matches(driver's function) will help your task.

Point of RGB value setting②

【Adjust only contrasting density with keeping same color balance】

⇒ Change each RGB values with same amount of number.



【In some color gamut, need to change RGB value a lot to get different color】

⇒ In the case that only 1 value is higher than other 2 value, the degree of color change is not remarkable. Change RGB value a lot (ex. 15 point) to adjust color.

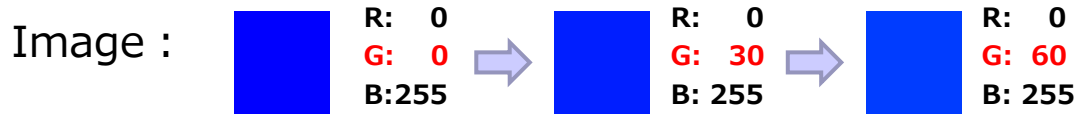

Pinpoint color matches(driver's utility function)

Pinpoint color matching is a useful function in the driver's utility.

(Property > utility > pinpoint color matches)

To use this function, it's easy to make efficiently-revised color pattern.

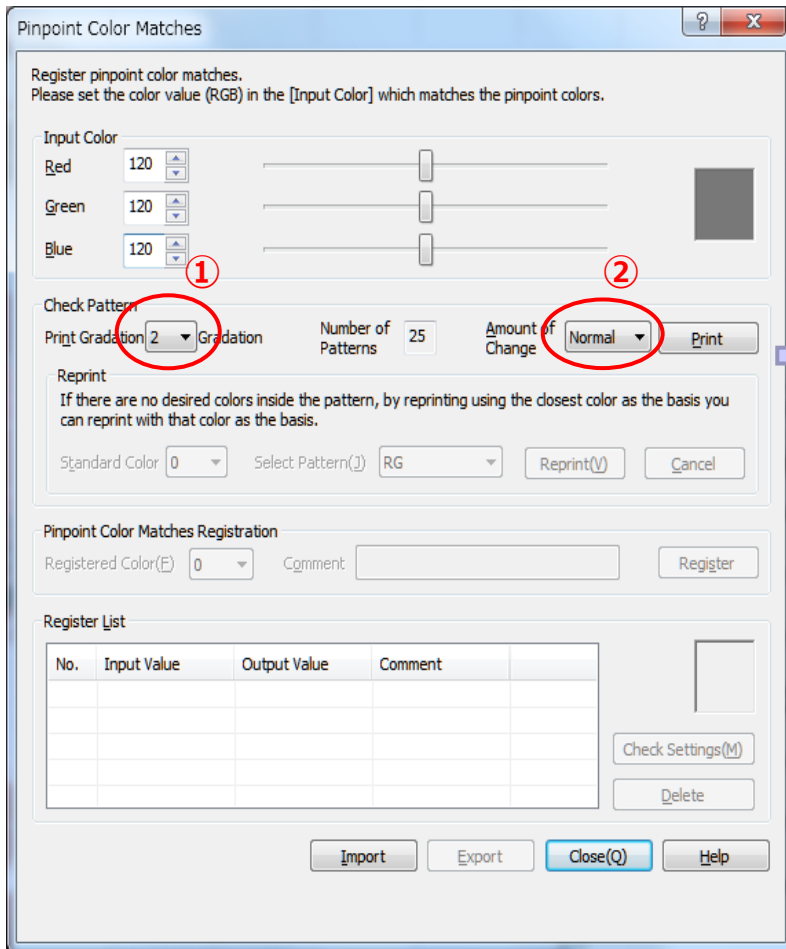

① Select Print Gradation

② Select Amount of change
(Large, Normal, Small)

Print

Automatically make color pattern below.

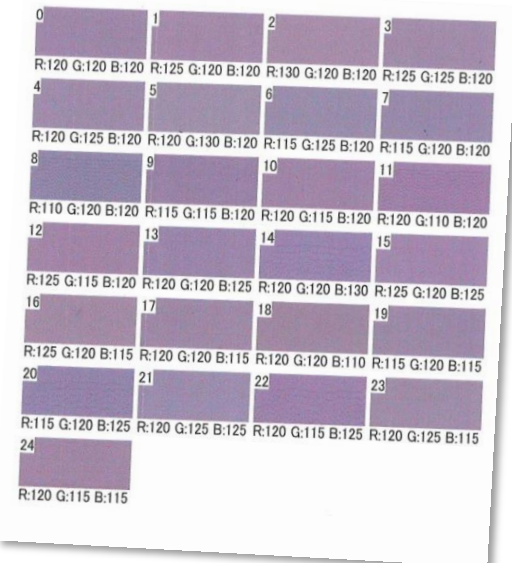

Pinpoint color matches(driver's utility function)

Color chart (image)

A image of color chart

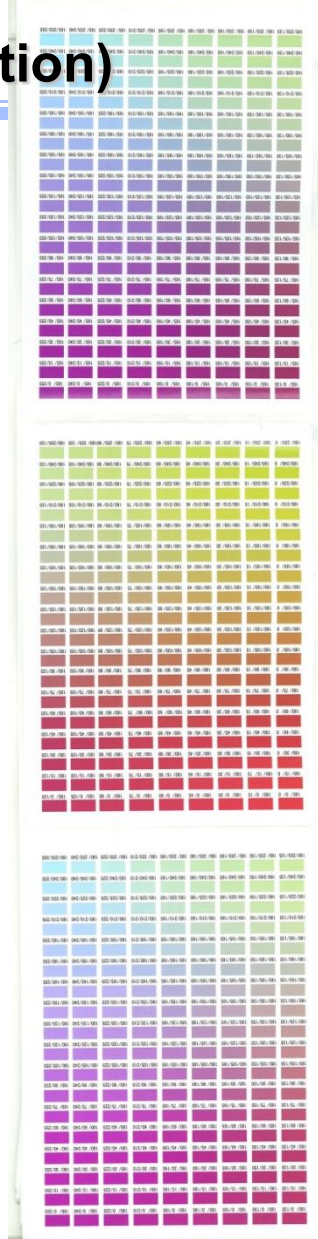

Second part

Print barcode and small characters clearly

**Highest
Priority**

① Make characters and Barcode with the personalized software, layout software which deal with the print drawing data, and then, print.

=Print characters and barcode with Vector(Drawing) image.

.. (Image Create SE, bartender, nice label, etc..)

(*reference1)

**In no choice but to
use bit map image**

② Modify a bit map image(JPEG etc.) into proper image for a inkjet printer. (*reference2)

1. Modify an anti-aliasing part (Make 2 value)
2. Modify Black part value.
3. Modify blank(white) part
4. Raise resolution.

Print barcode and small characters clearly

-Example creating data made with layout software.

It prefer for characters and barcode to be output from software dealing with vector data.
=Output characters and barcode with Image Create SE, bartender, nice label, etc.

[Ex]Creating demo data for Cartes



(Before)



Delete small characters,
barcode with Photoshop.

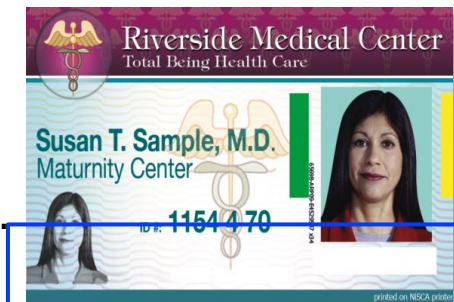

(After)

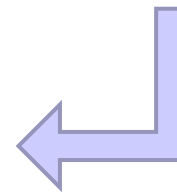
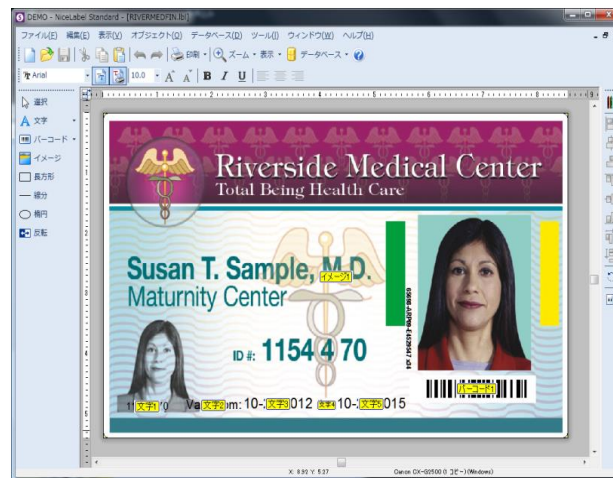

After delete the
characters and barcode,
put this image on nice
label and then, **add
characters and
barcode on this.**

Print barcode and small characters clearly

-Modifying bit map image

1. Modify anti-aliasing part (Make 2 value)

anti-aliasing_...this is function to change color gradually for integrating outline of stuff with background.

Anti- aliasing image

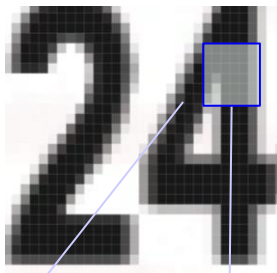

Modify it into the 2 value data

(operation example with Photoshop)
Image> color tone revision> 2 graduat



It's possible not to re-appear outline in detail because print in CMY, second color, for printing gray part, not black data(PGB=0,0,0).

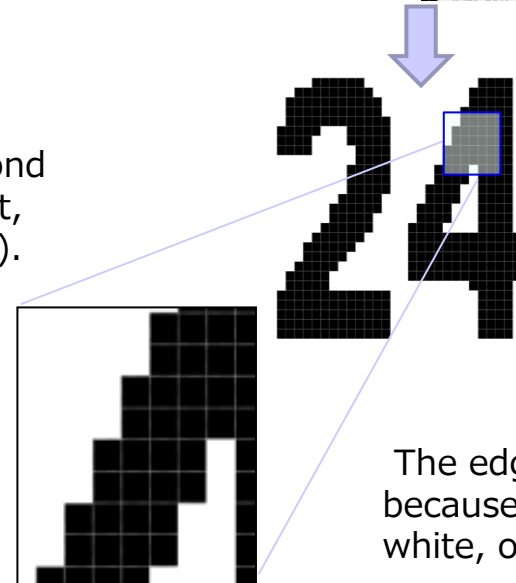
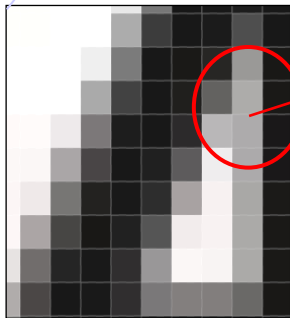

The edge is clear because of Black and white, only 2 value

Print barcode and small characters clearly

-Modifying bit map image

2. Modify black value

Even if look like black, RGB value is sometimes not 0, and then, it sometimes print black in CMY, and it may happen for printer not to express sophisticated level of itself.

In this case, modify RGB into 0.

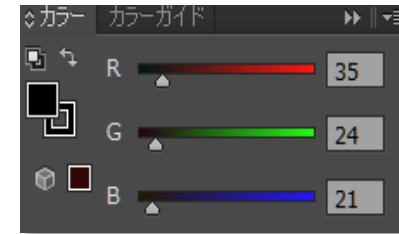

3. Modify blank (white)

In spite of that Sub spitting mode is OFF, the dust is on the blank part,] in this case, RGB is likely not to be(255, 255, 255) even if it seems like white.

In so, modify RGB of white blank into 255.

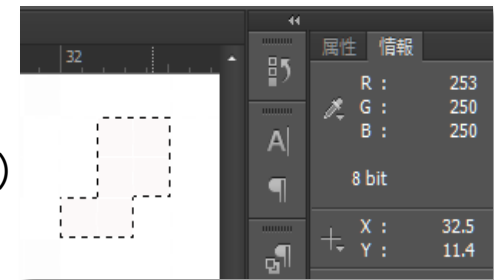

4. Raise resolution

If resolution is low, edge may be not printed clearly. In this case, change image to high resolution one.

(*reference about 3 resolution)

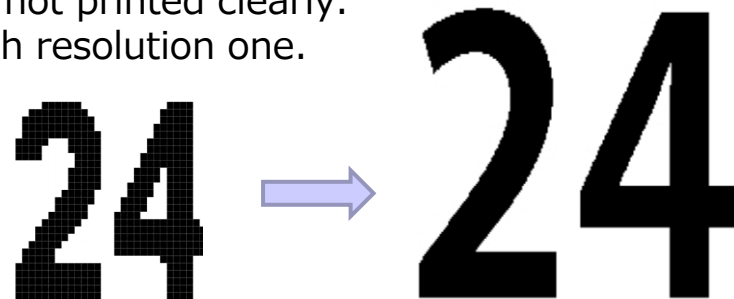

Point of Color Adjustment, Creating Image and Modification

(CMYK image and RGB image)

As of now, a lot of image are created under the CMYK color gamut setting. The data created under the setting of CMYK color gamut is set by more narrow range than RGB. So, printer which color gamut is based on RGB, may do not use full gamut. Please understand the difference between CMYK image and RGB image and modify efficiently.

【Gamut】

RGB

reappeared
color value
on display

>

CMYK

Reappeared color value
on printed media.
(Ink mix rate)

There is gap between gamut create by print(CMYK) and gamut by monitor(RGB). For making the both near, it is limited to be covert within RGB range when change CMYK into RGB.

In the case of the on-demand printer handling color data with digital through PC, if you do color set in CMYK same as intaglio printing, it's forced to covert into RGB during work. As a result, it comes data without using gamut itself fully.

Point of Color Adjustment, Creating Image and Modification

(CMYK image and RGB image)

example for converting CMYK image into RGB

Ex 1) $R=255, G=0, B=0$
Max

$R=230, G=0, B=1$
8

•C = , M=100, Y=100, K, =0

max

Coca-Cola
shareacoke.co.uk

It is set as M=100, Y=100 (red maximum value), but if convert with illustrator, the value is not convert into R=255 (maximum value).

Ex 2) $R=35, G=24, B=21$

•C = 0, M=0, Y=0, K=100

Fat 0.0g 0%

Not convert from (K=100) into (RGB=0)

Point of Color Adjustment, Creating Image and Modification

(CMYK image and RGB image)

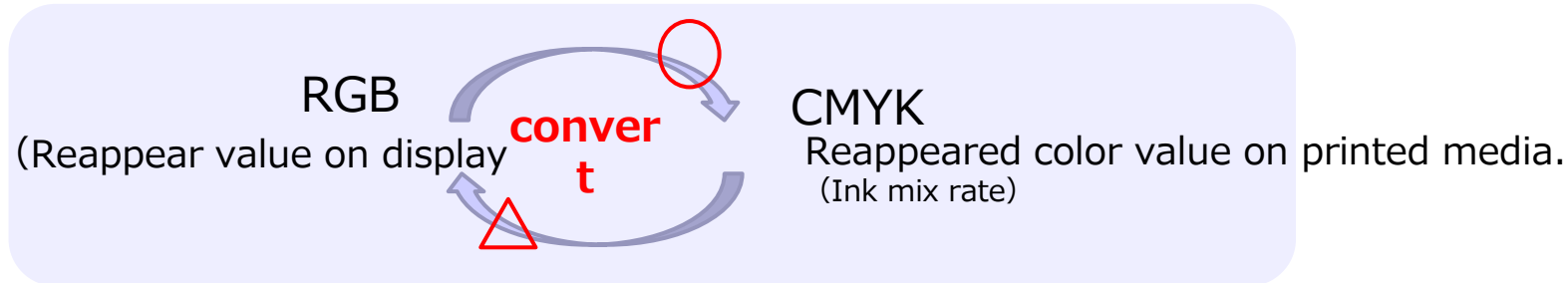

- When creating new data, or in the ease case to reset with EPS, AI data etc., do color setting in RGB again.
- As for modifying bit map, revise color considering convert from CMYK into RGB.

Point of creating new design

(in the case of out sourcing sample)

- Create data after setting color mode as RGB necessary.
- When appoint black character and black only, set RGB = 0 .
- Avoid the method to convert into RGB after setting by CMYK.
- Anti-aliasing should be OFF(Without check)(Illustrator)
- When editing resolution by Photoshop, select the nearest neighbor.

Reference 1

What is the vector(drawing) image.

- data image of vector image

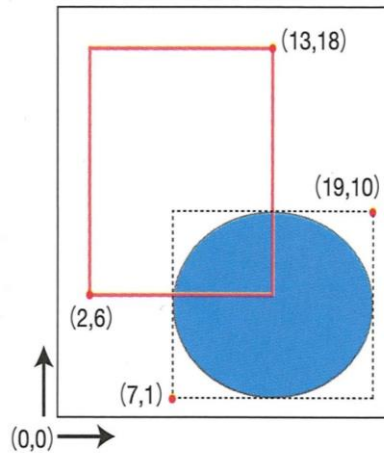

```
%PDF-1.4
%
1 0 obj<</Pages 2 0 R/Type/Catalog/Metadata 4416 0 R>>
endobj
2 0 obj<</Count 1/Kids[6 0 R]/Type/Pages>>
endobj
3 0 obj<</ModDate(D:20041221173350+09'00')/CreationDate(D:
20041220100303+09'00')/Title(sonnyelicson 9)/
Creator(Illustrator)/Producer(Adobe PDF library 6.66)>>
endobj
5 0 obj null
endobj
6 0 obj<</Contents 4406 0 R/Type/Page/Parent 2 0 R/Thumb
4415 0 R/MediaBox[0.0 0.0 595.27557 841.88977]/BleedBox[0.0
0.0 595.27557 841.88977]/TrimBox[0.0 0.0 595.27557
841.88977]/ArtBox[266.58008 415.68066 333.17969
```

図形の位置や形状、色などがコード化(数値化)されて記録される。記述はテキストベースのコーディングなのでビットマップ画像よりも基本的にファイル容量が軽くてすむ。Illustratorで作った図形をエディタなどで開くと、膨大なテキストデータとなる。

It has image data as formula and it appears the image every time in accordance with environment.
That's why it is easy to expand and change the format.

When printing, it can output various resolution and revise barcode in accordance with printer.

It can make printer function maximum like print sophisticated and subtle characters and barcode.

Reference 2

What is bit map image

- bit map image



It regards image as pixel of dot matrix and deal with them as line information of color / density value of pixel based on RGB.



It has fixed data as pixel mass.

It is not easy to modify form. If expanding the image, it become rough image because the number of pixel is not different.



In need to create or modify data following printer features.

Proper resolution

Resolution of print head is 1200dpi.

If setting 1200dpi, image is very good but data is very heavy.

Print by 600dpi is still good and we recommend 600dpi.

Point to draw logo

When pointing resolution by JPEG with illustrator and drawing, you must set the size to template on where you put on, and draw with appointed resolution.

If you convert on the part where you put on it, the resolution is changed itself.

Ink cost calculation

Create file for use with Ink cost calculation tool

1. Left click Printer Swiftcolor at Device and Printer menu
2. Right click and port from USB to FILE (Print to file)
3. Select picture and print, Dialog box “Output file name” will Appeared and input file name. Any name can be used but file type name must be “.prn”. Also if you specify file pass before file name, file will be created at the specified place. For example:

C:\Users\011916\Desktop\prnfile\card sample.prn
File Pass **File Name**

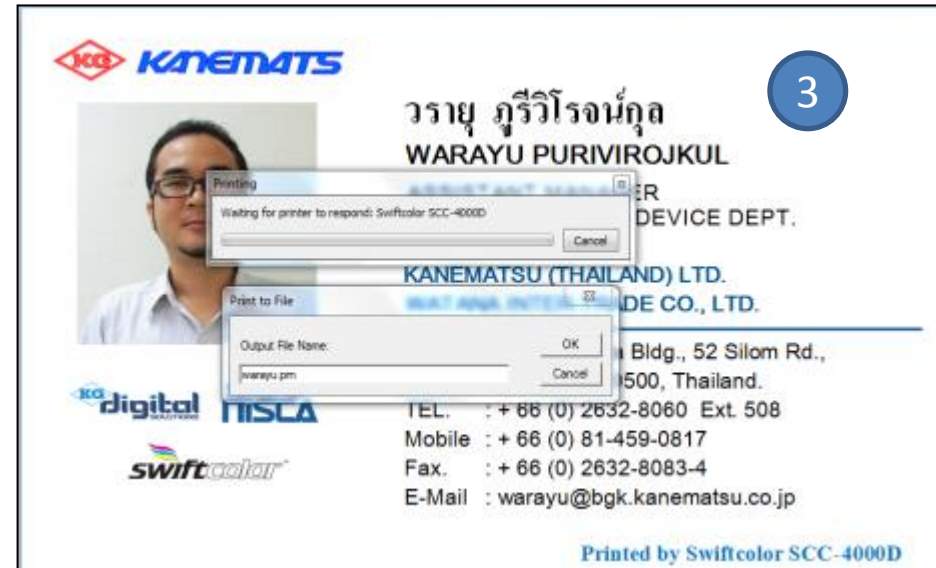
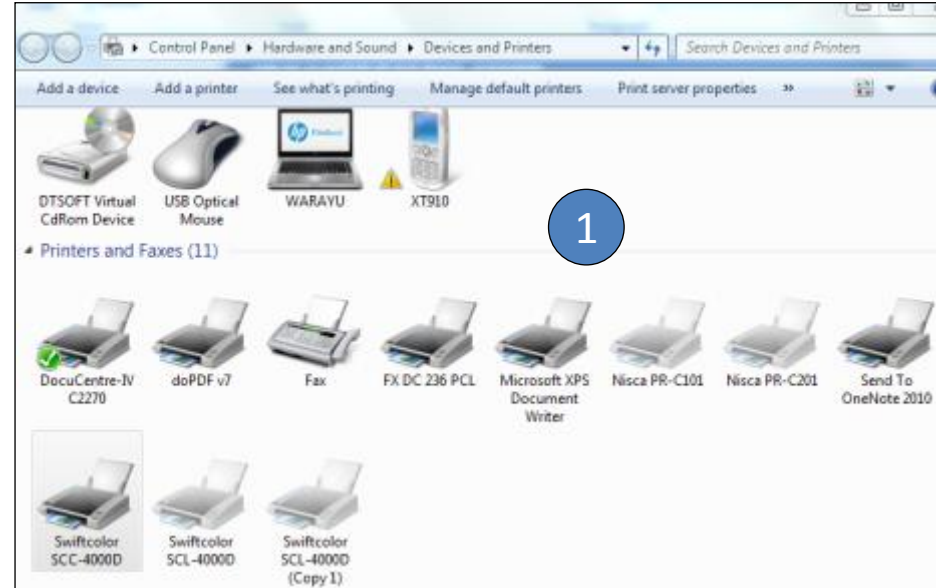
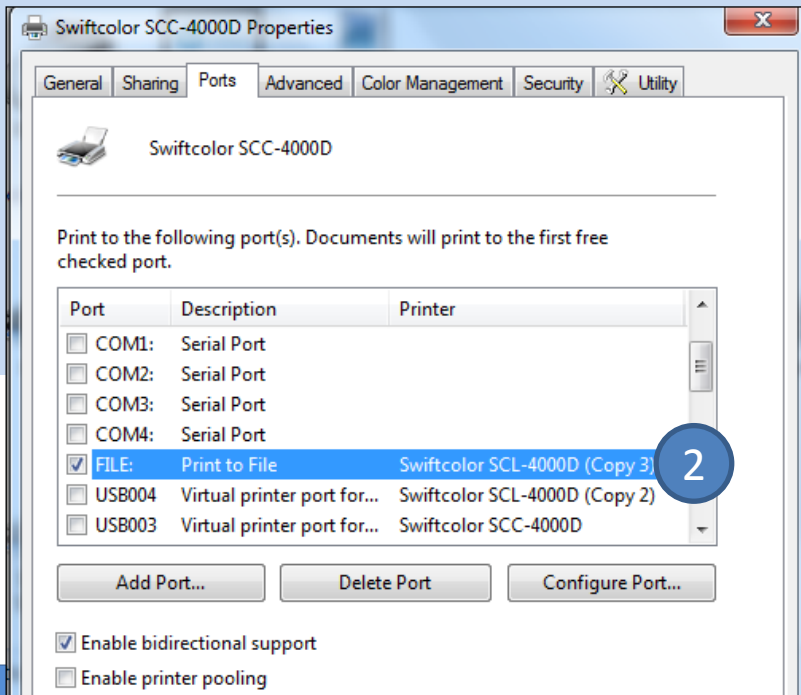

Open program Ink cost calculation tool

- Setting printer type to card printer
- Choose XXX.prn (that create in last step)
- Input ink cost and print per job (More print / job is lower cost)
- Click Cost Calculation → You will know estimate cost

The screenshot shows the InkCostCalculator application window. The title bar reads "InkCostCalculator". There are two tabs: "Setting" and "Version".

Input Parameter

Print File Path : C:\Users\warayu\Desktop\warayu.prn

Label / Job : 100 label / 1 job Ink CRG Cost : \$ 130

Total Print Count / Day : 100 label

Cost Calculation(C)

Cost Calculation Result

	Ink amount		Cost	Printhead life
Black :	0.00223 ml	44784 Label printable	\$ 0.00290	968992 Label
Cyan :	0.00216 ml	46251 Label printable	\$ 0.00281	1201923 Label
Magenta :	0.00190 ml	52636 Label printable	\$ 0.00247	1106194 Label
Yellow :	0.00141 ml	70833 Label printable	\$ 0.00184	1388888 Label
		Total Cost :	\$ 0.01002	

Maintenance cartridge exchange timing : - day

Close(X)

SCC-4000D_Medie Hole condition



Information necessary to troubleshoot:

◆ Printer serial number:

- Printer serial number
- Firmware version
- Printer log data (both .txt and .bin files) → Please get log data soon after the trouble occurred.
- Situation detail: How it was occurred (trigger of the trouble), How it was handled, Result after any actions.

How to get printer log:

SCC-2000D Service Utility

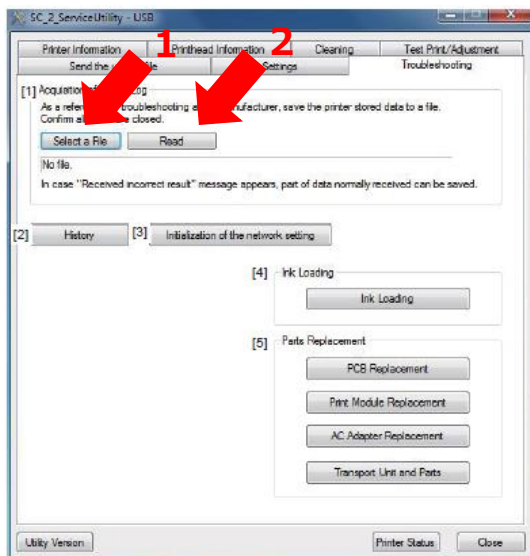

(SCC-2000D Service Manual 9-11)

SCC-4000D Service Utility

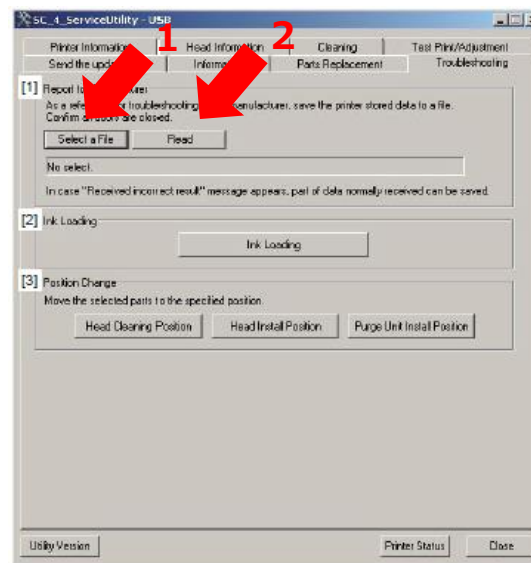

(SCC-4000D Service Manual 9-11)

In addition to above, detail information for each phenomena written in the following pages is helpful.

Information necessary to troubleshoot:

1. In case of image failure
 - Actual failure image, and how it is defective
 - Actual printed samples, printed nozzle check pattern, defective location.
 - Paper type and size
 - When it was occurred. (after powered on, it appeared while printing, after auto cleaning was performed, after paper jammed, etc)
 - Failure frequency
 - How it was changed after performing manual cleanings (light/medium/strong)
 - Please note on the print sample when it was printed (after printing XX pages, after strong cleaning 2times, etc)
 - Any other actions and its result (reinstalling print head, etc)

How to print Nozzle Check pattern:
SCC-2000D Service Utility

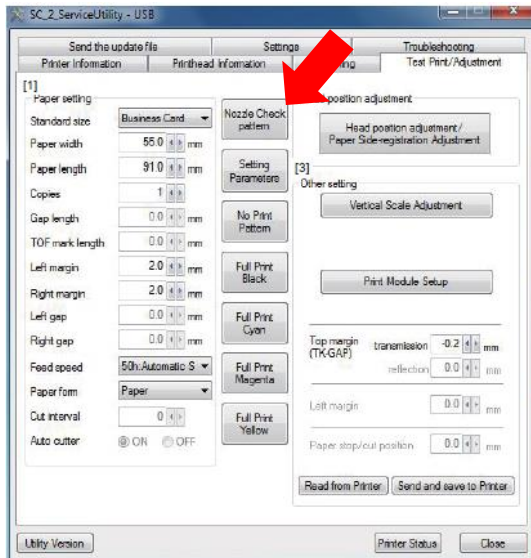

(SCC-2000D Service Manual 9-7)

SCC-4000D Service Utility

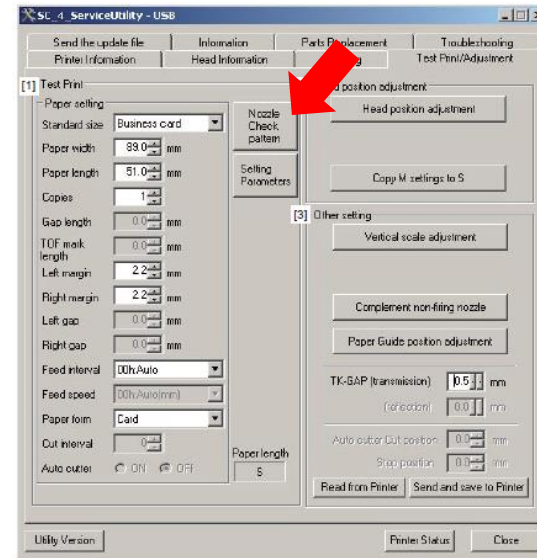

(SCC-4000D Service Manual 5-61)

Information necessary to troubleshoot:

2. In case of paper jam

- Whether it is modified to handle plastic card or not. (SCC-4000D)
- If the paper lever is set to correct position
- Error code (check with Service Utility)
- Paper type and size
- How it was jammed? (skewed and stopped on the transport belt, or stuck at a certain position. (photo if any)
- In case it stopped in the middle of printing, image sample where it jammed (Exact jammed page).
- Failure frequency
- In case with SCC-2000D, if the media guide is set to correct position.

How to confirm the position of Paper Lever:

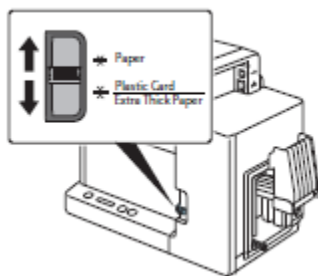

SCC-2000D



- Set the lever to the appropriate position according to the paper to be printed on.
Plastic card or Extra thick paper:
Set it to [Plastic Card/Extra Thick Paper]
Paper other than above:
Set it to [Paper]

SCC-2000D User's Guide P.13

SCC-4000D

● Setting the thick paper transport lever	
When using thick paper	When using paper other than thick paper
Pull out the thick paper transport lever in the paper delivery slot.	Push the thick paper transport lever in the paper delivery slot.
	

SCC-4000D User's Guide P.23

Information necessary to troubleshoot:

How to confirm the Error Code:

SCC-2000D Service Utility

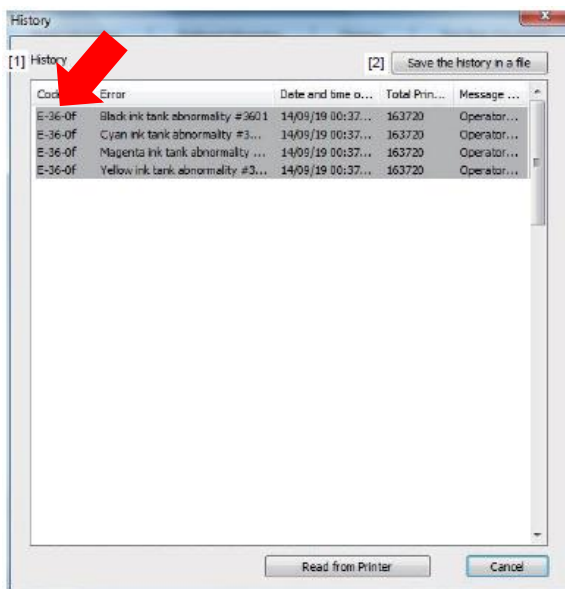

(SCC-2000D Service Manual 9-12)

SCC-4000D Service Utility

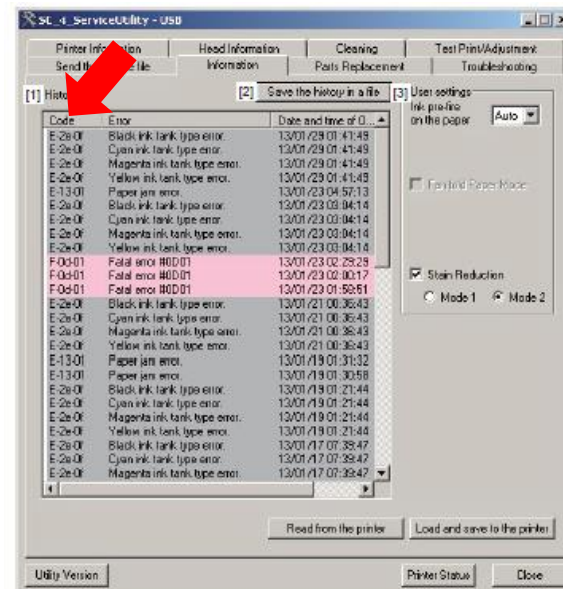

(SCC-4000D Service Manual 5-64)

Information necessary to troubleshoot:

3. In case of printer driver malfunction
 - Problem detail
 - Printer Driver version
 - Application software and its version
 - Printer driver setting file
 - Setting from printer driver, or setting from application software

how to export driver setting:

SCC-2000D Service Utility

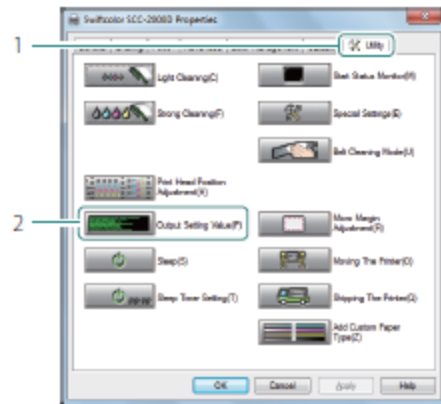

(SCC-2000D User's Guide P.122)

SCC-4000D Service Utility

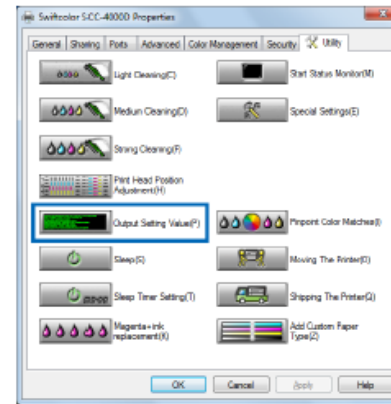

(SCC-4000D User's Guide P.162)

4. In case other than above
 - Error code
 - Problem detail

How to utilize print head: SwiftColor sample image design

2015/1/19

Canon Finetech Inc.

IJ Printer printing mechanism

SCC-4000D / 2000D

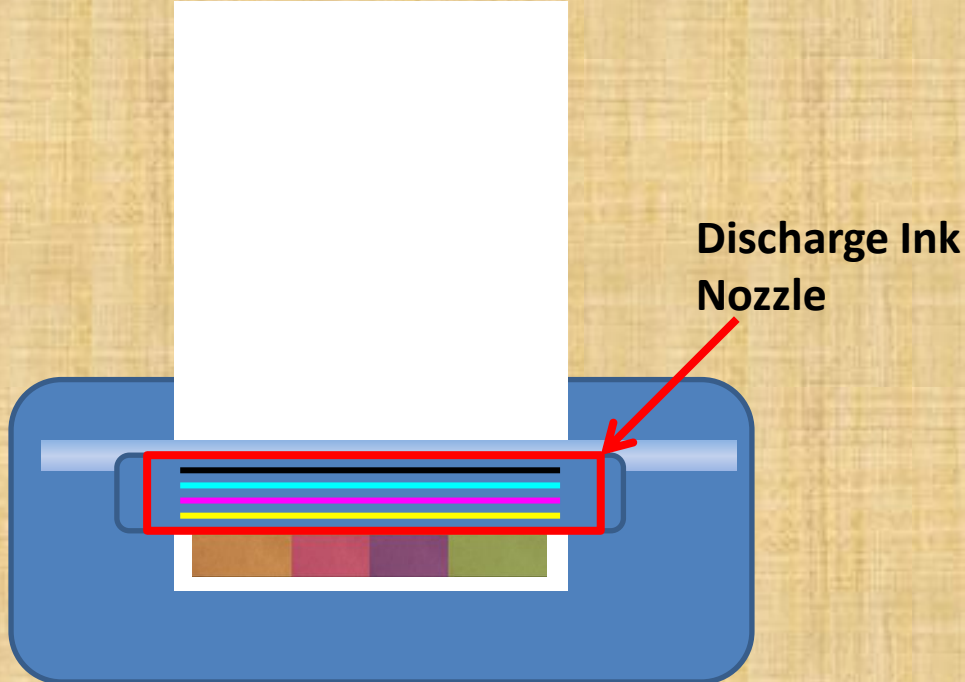

Media feeding direction



Media moves under the fixed head at a constant speed and images are created.

"Line head"

Serial Printer

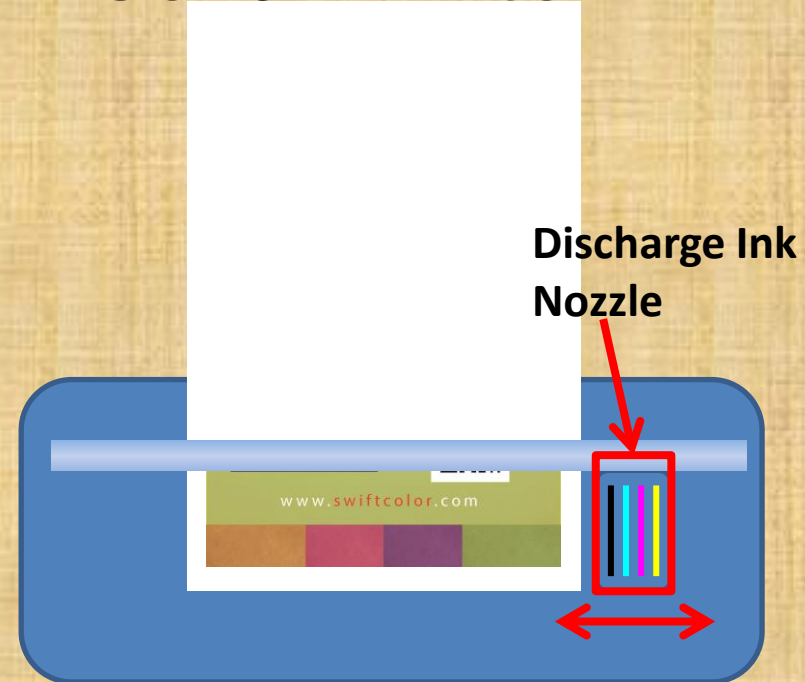

Media moves bit by bit for printing image, while head moves from right to left and images are created.

"Serial head"

IJ Printer printing mechanism

SCC-4000D/2000D

- Fast
 - High
 - Less
- system

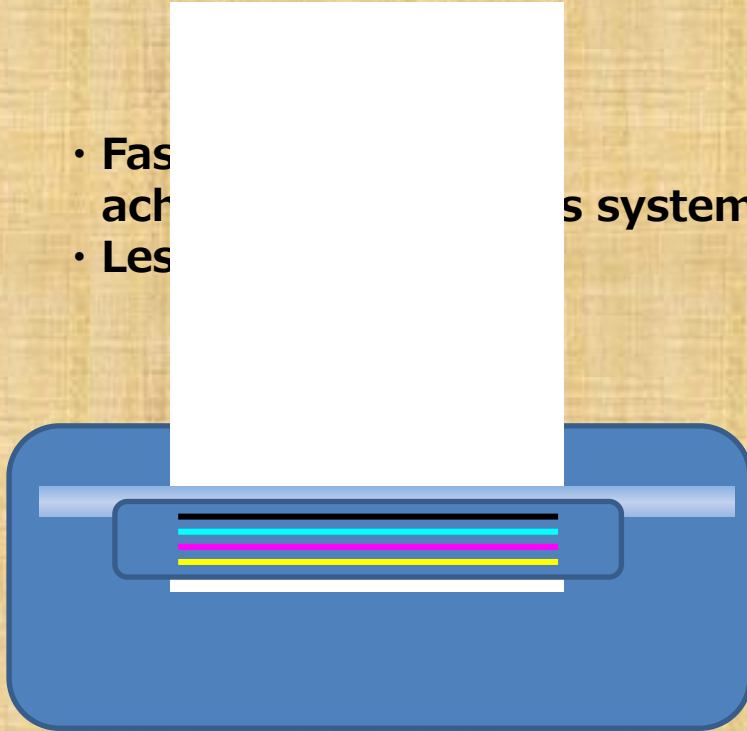

Serial Printer

- High
 - Discha
 - Lower
- system
- system
- nter

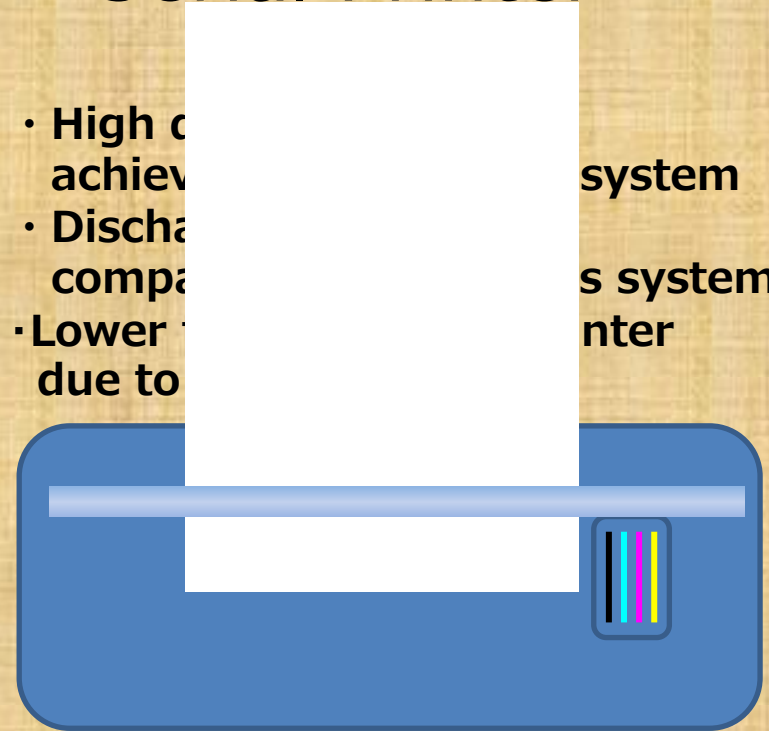

IJ Printer printing mechanism

SCC-4000D/2000D

- Fast
 - High
 - Less
- system

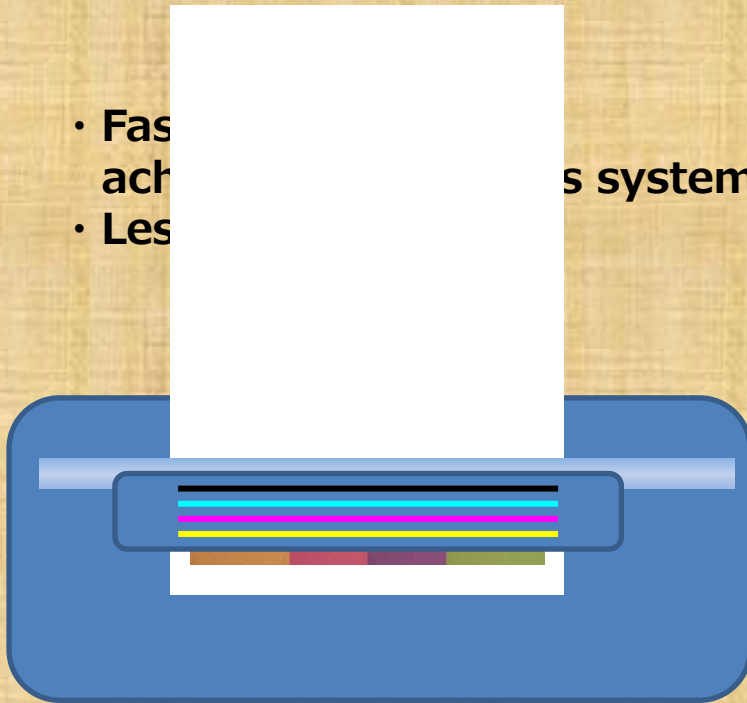

Serial Printer

- High
 - Discha
 - Lower
- system
- system
- and printer
- due to

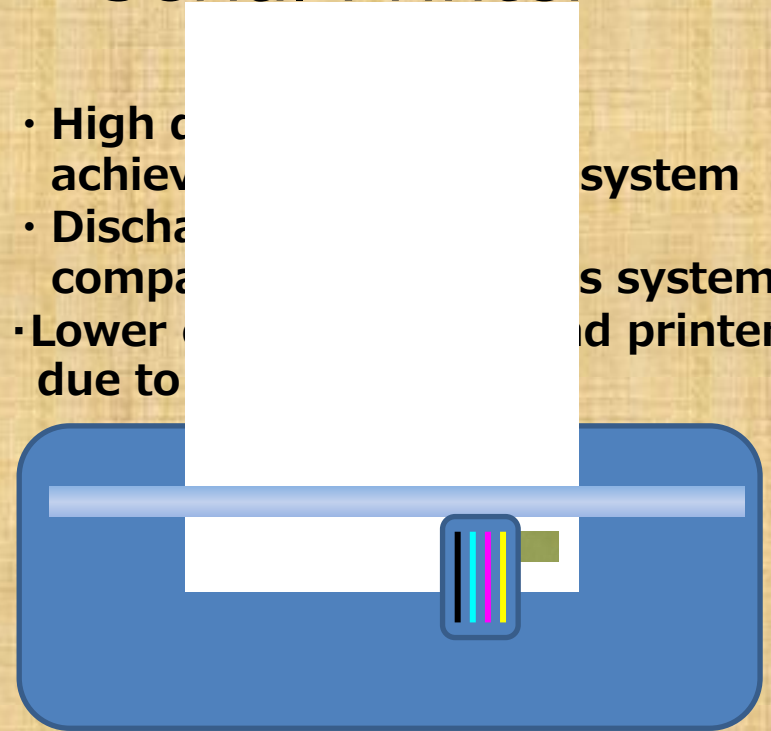

IJ Printer printing mechanism

SCC-4000D/2000D

- Fast
 - High
 - Less
- system

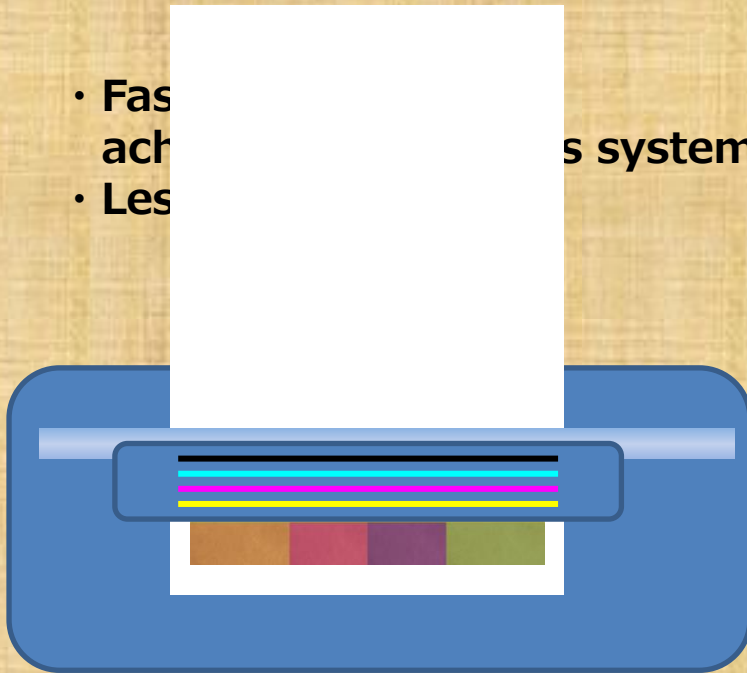

Serial Printer

- High
 - Discha
 - Lower
- system
- system
- and printer
- due to

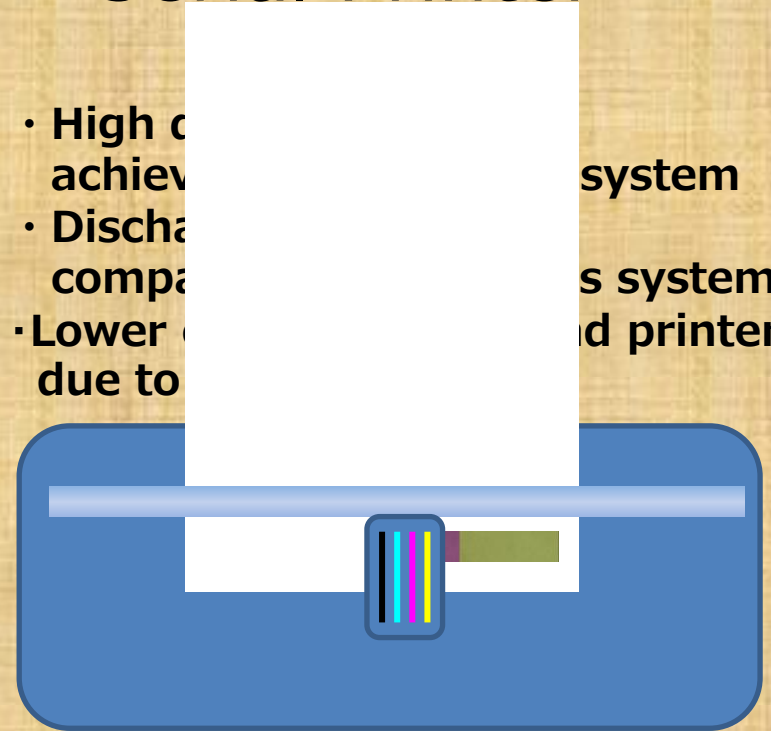

IJ Printer printing mechanism

SCC-4000D/2000D

- Fast
- High
- Less

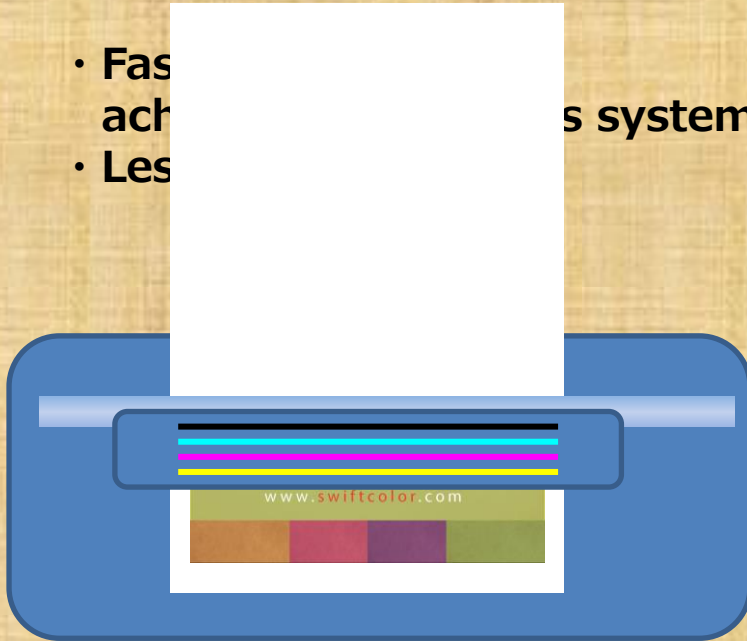

Serial Printer

- High
- Discha
- Lower

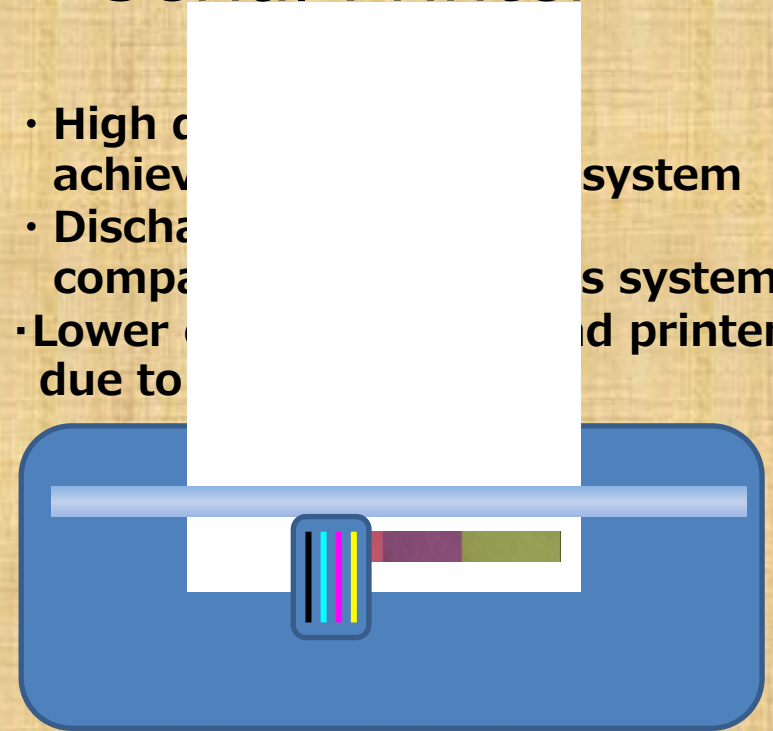

IJ Printer printing mechanism

SCC-4000D/2000D

- Fast
- High
- Less

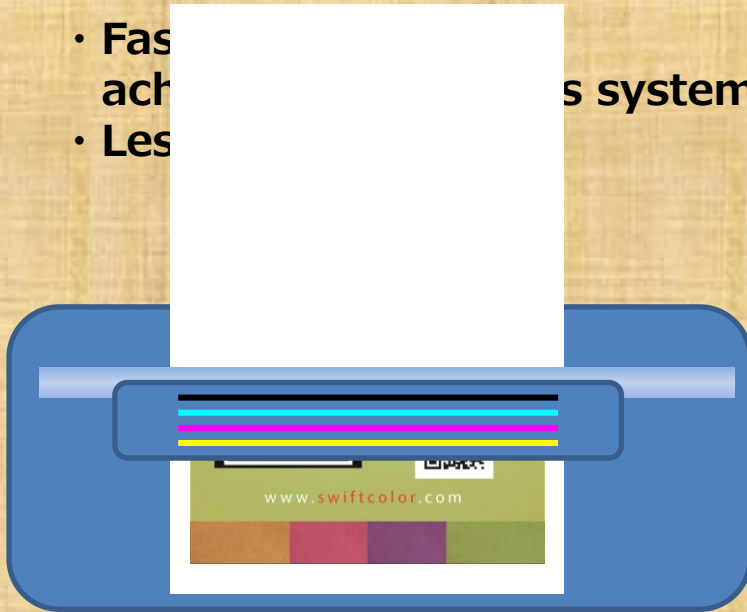

Serial Printer

- High
- Discha
- Lower

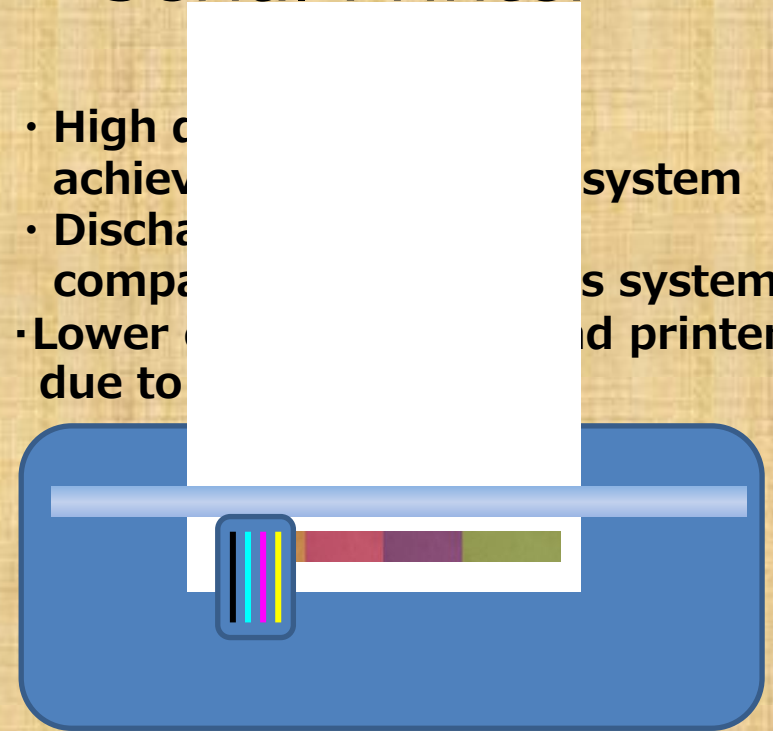

IJ Printer printing mechanism

SCC-4000D/2000D

- Fast print speed
- Achieves high resolution system
- Less

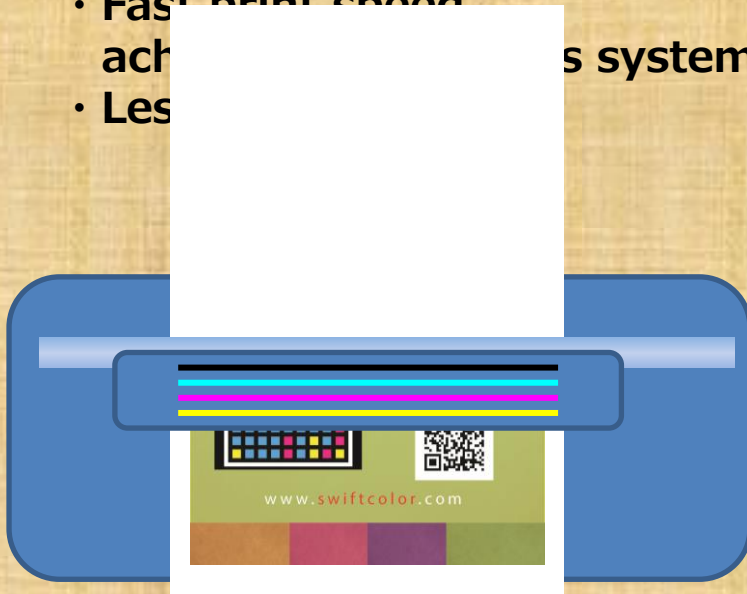

Serial Printer

- High cost
 - High resolution system
 - Discharge
 - Compact
 - Lower cost
 - due to
- system
system
d printer

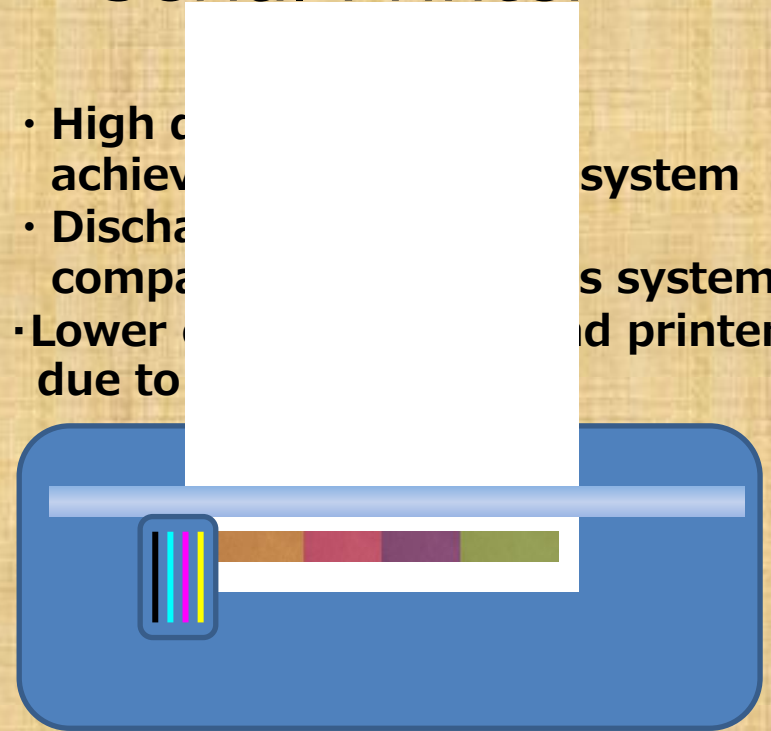

IJ Printer printing mechanism

SCC-4000D/2000D

- Fast print speed
- Achieves high resolution system
- Less ink consumption

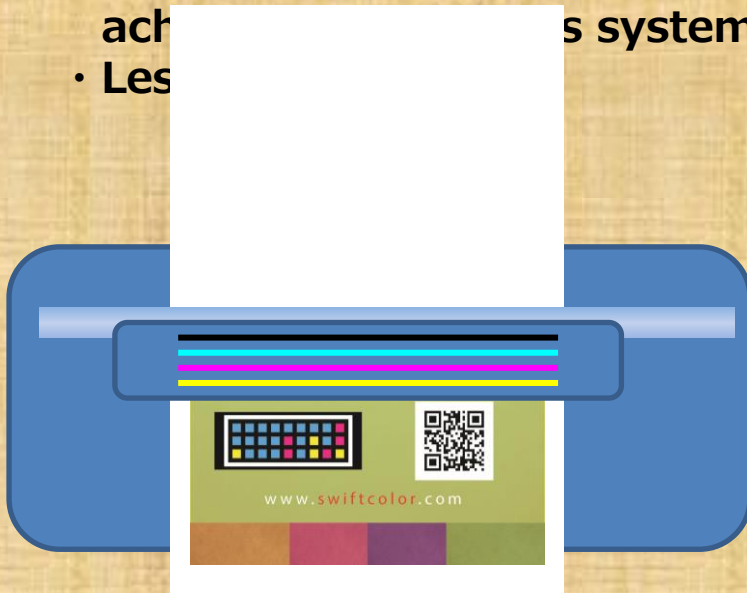

Serial Printer

- High cost
- High resolution system
- Discharge system
- Compact system
- Lower cost per page
- due to

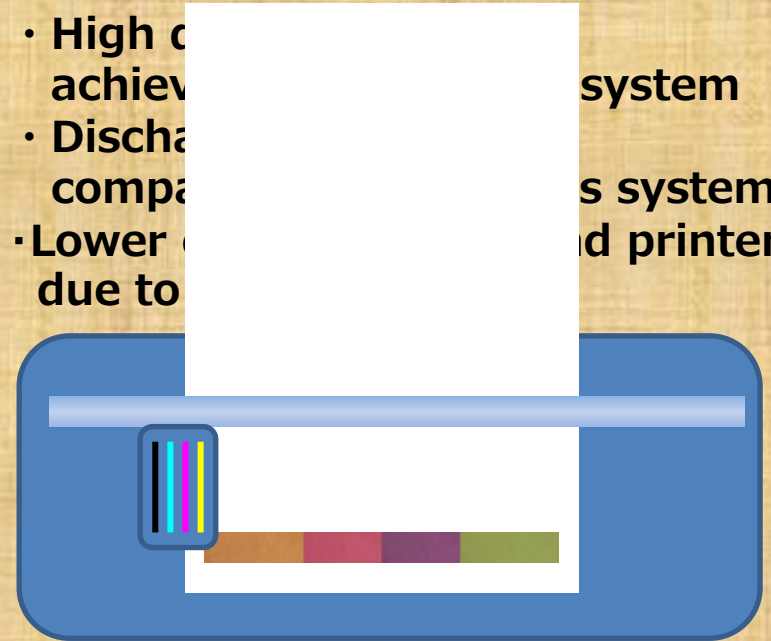

IJ Printer printing mechanism

SCC-4000D/2000D

- Fast print speed achieved by one pass system
- Less

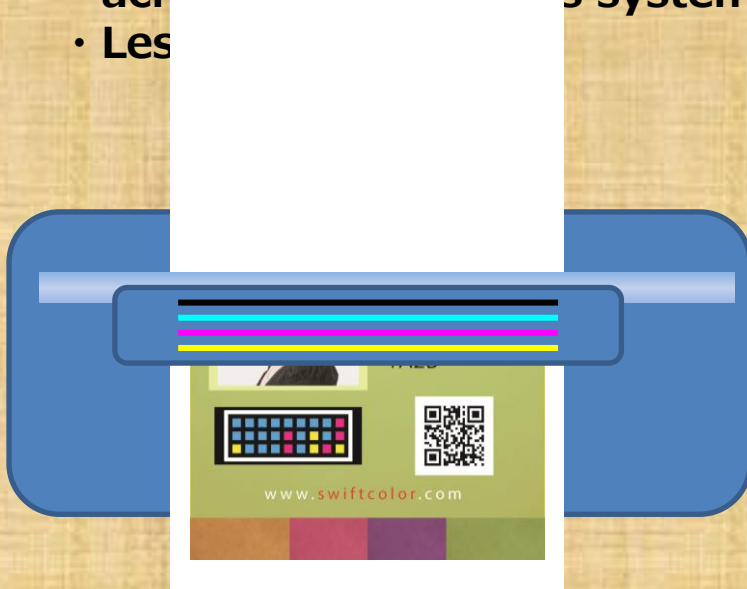

Serial Printer

- High cost achieved by serial system
- Discharge compensation system
- Lower cost due to

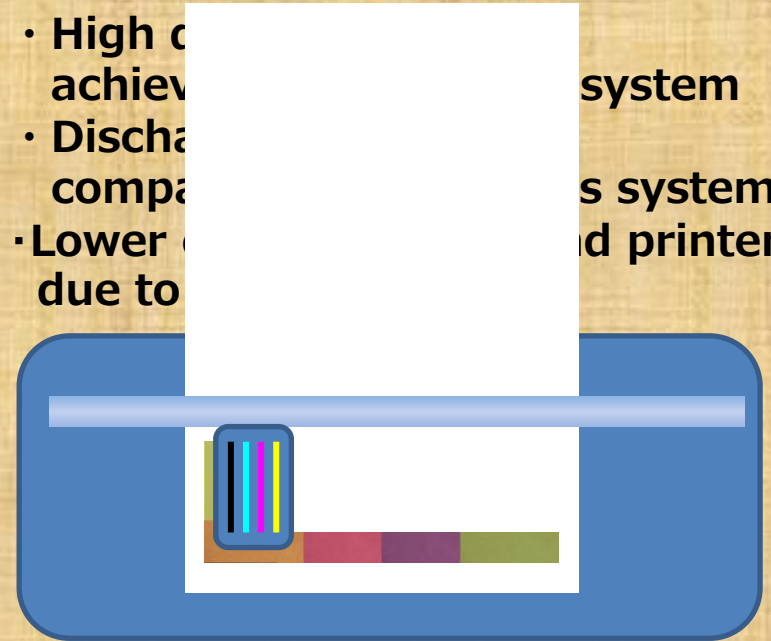

IJ Printer printing mechanism

SCC-4000D/2000D

- Fast print speed achieved by one pass system
- Less



Serial Printer

- High cost system
- Discharge system
- Lower cost printer

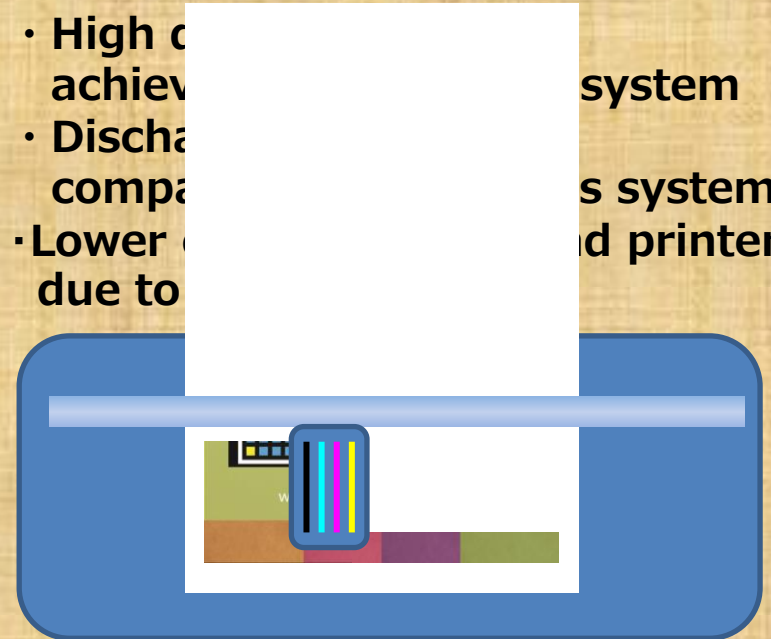

IJ Printer printing mechanism

SCC-4000D/2000D

- Fast print speed achieved by one pass system
- Less moving part

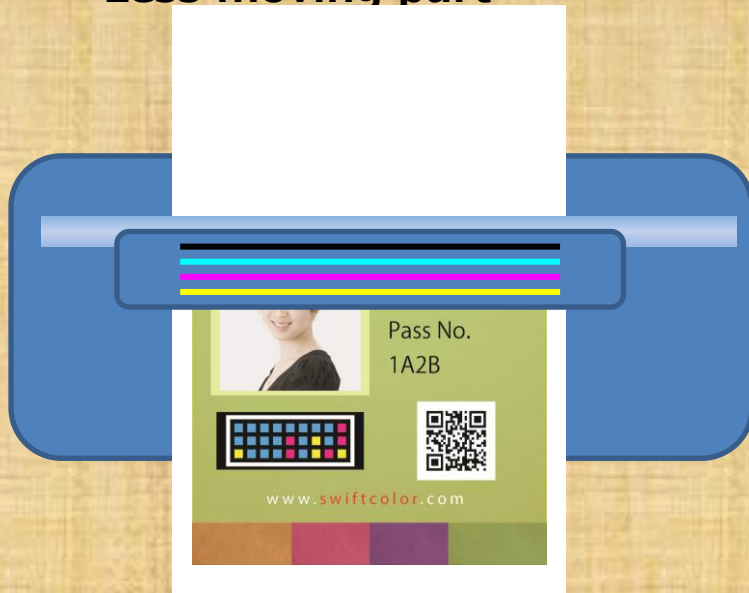

Serial Printer

- High cost achieved by serial system
- Discharge compact system
- Lower cost due to printer

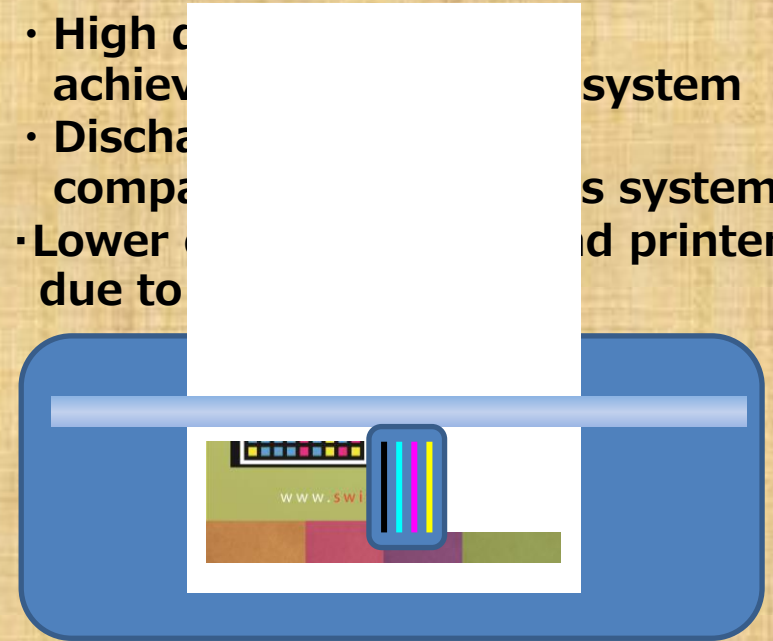

IJ Printer printing mechanism

SCC-4000D / 2000D

- Fast print speed achieved by one pass system
- Less moving part



Serial Printer

- High cost per page achieved by one pass system
- Discharge system compared to IJ system
- Lower cost per page due to multiple passes

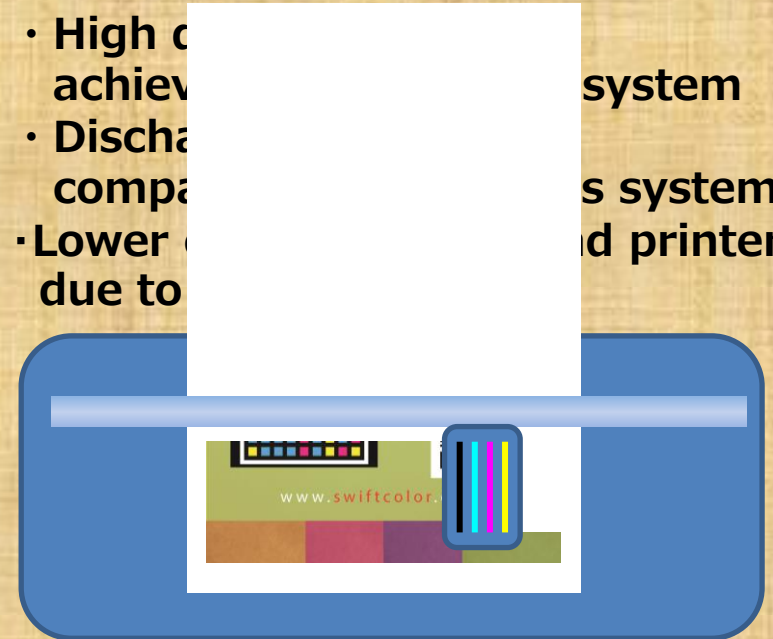

IJ Printer printing mechanism

SCC-4000D/2000D

- Fast print speed achieved by one pass system
- Less moving part

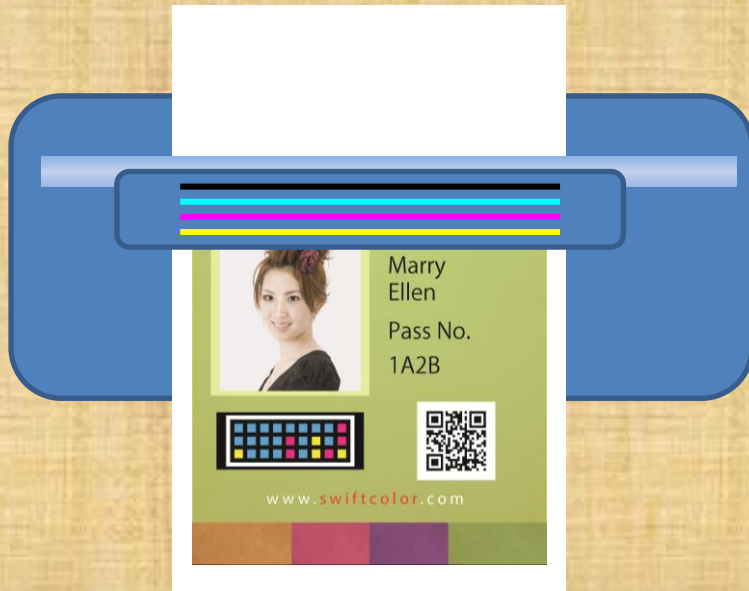

Serial Printer

- High cost system
- Discharge system
- Lower cost printer

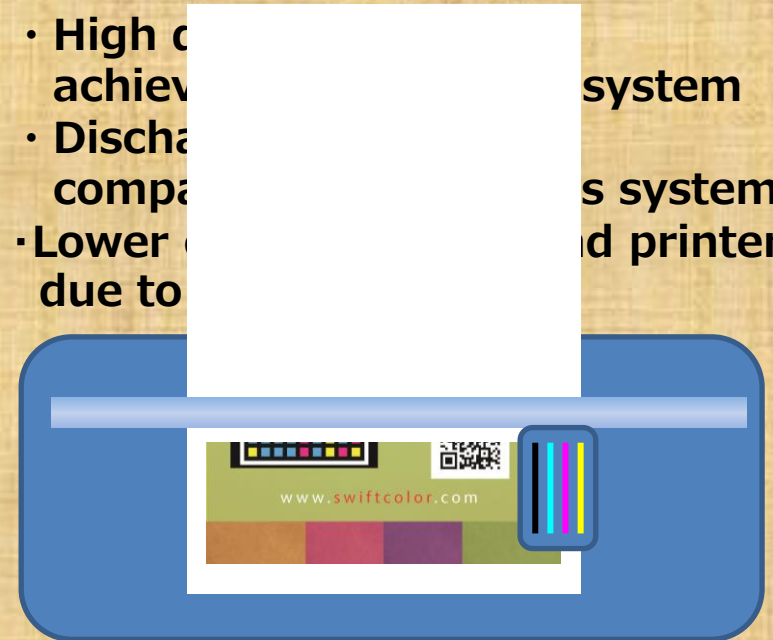

IJ Printer printing mechanism

SCC-4000D/2000D

- Fast print speed achieved by one pass system
- Less moving part

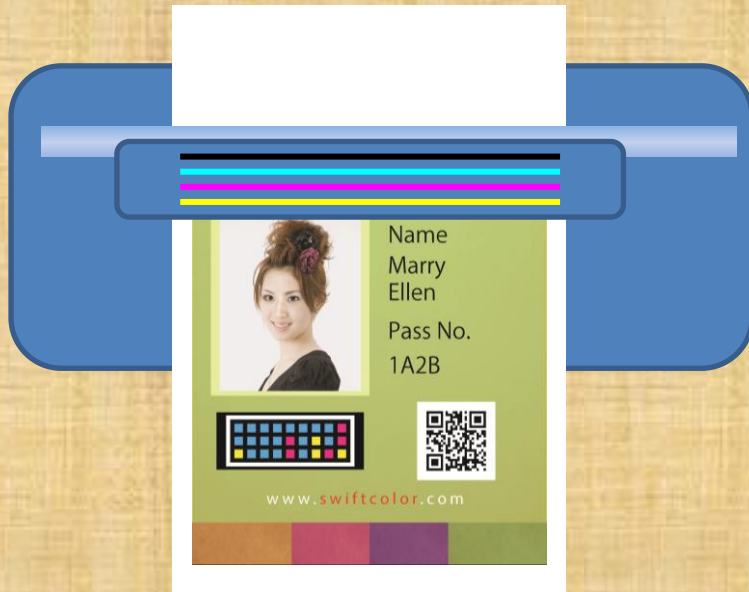

Serial Printer

- High cost system
- Discharge system
- Lower cost printer

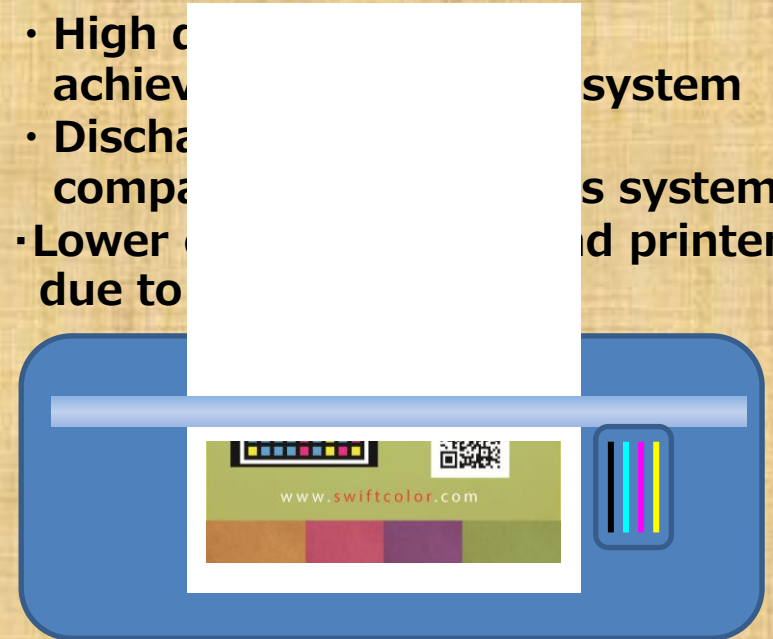

IJ Printer printing mechanism

SCC-4000D / 2000D

- Fast print speed achieved by one pass system
- Less moving part

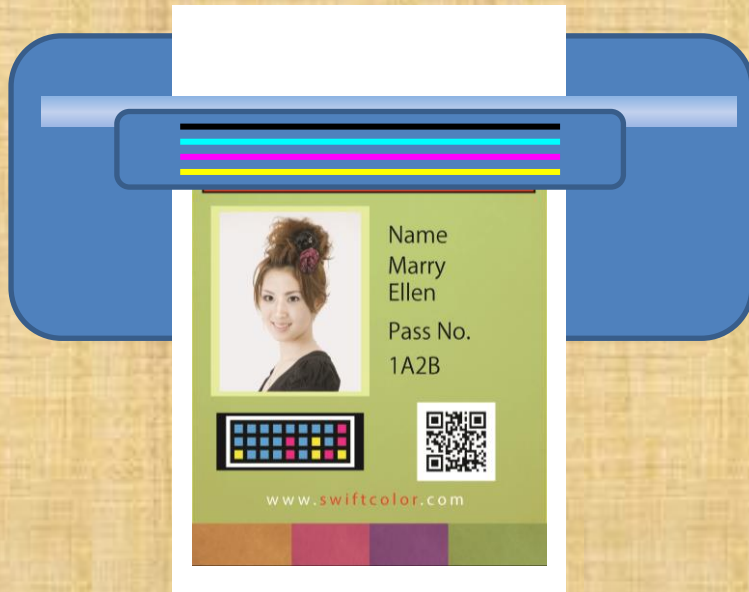

Serial Printer

- High quality image achieved by multi pass system
- Discharge compensation system
- Lower cost per page than IJ printer due to

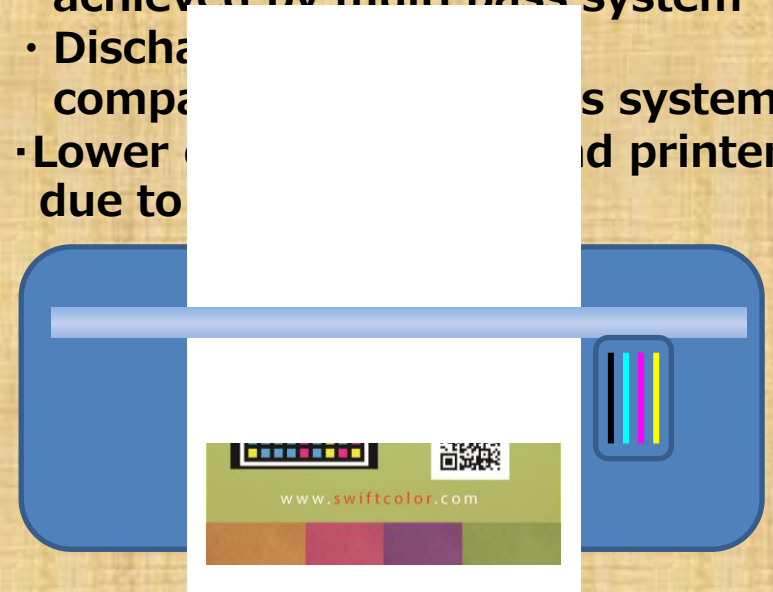

IJ Printer printing mechanism

SCC-4000D/2000D

- Fast print speed achieved by one pass system
- Less moving part



Serial Printer

- High quality image achieved by multi pass system
- Discharge compensation system
- Lower cost per page than IJ printer due to

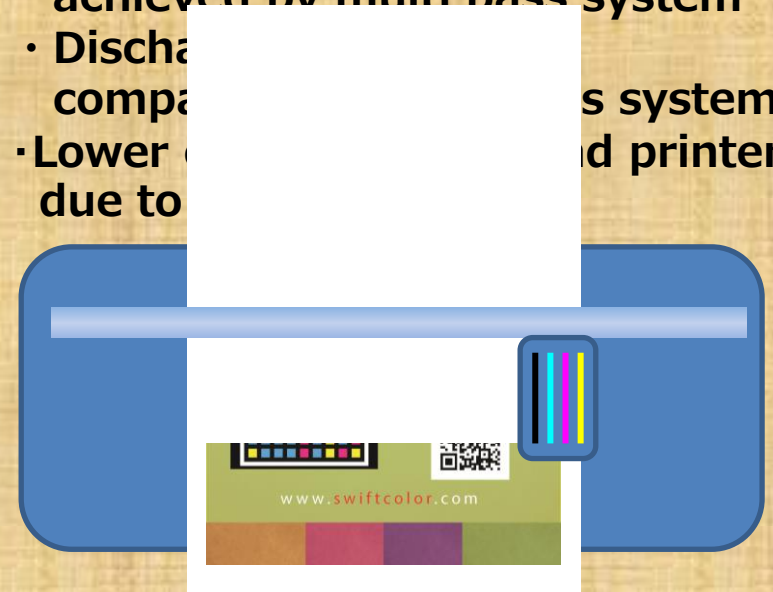

IJ Printer printing mechanism

SCC-4000D/2000D

- Fast print speed achieved by one pass system
- Less moving part

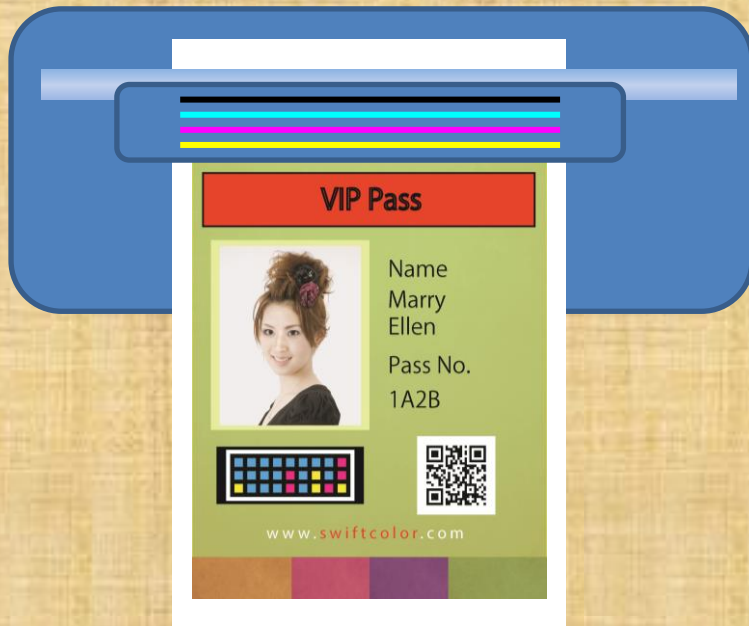

Serial Printer

- High quality image achieved by multi pass system
- Discharge compensation system
- Lower cost per page than IJ printer due to

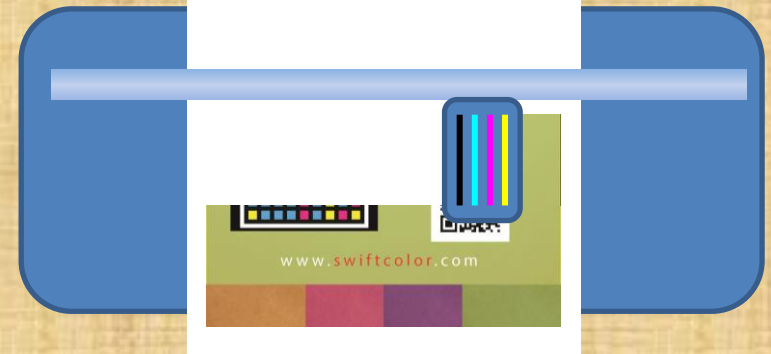

IJ Printer printing mechanism

SCC-4000D / 2000D

- Fast print speed achieved by one pass system
- Less moving part



Serial Printer

- High quality image achieved by multi pass system
- Discharge compensation system
- Lower cost per page than IJ printer due to

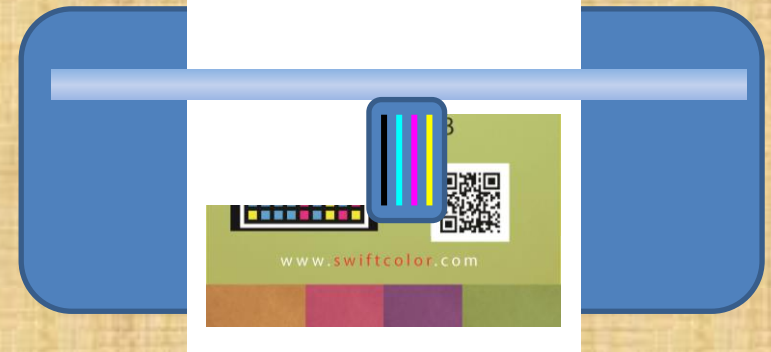

IJ Printer printing mechanism

SCC-4000D / 2000D

- Fast print speed achieved by one pass system
- Less moving part



Serial Printer

- High quality image achieved by multi pass system
- Discharge compensation system
- Lower cost per page than IJ printer due to



IJ Printer printing mechanism

SCC-4000D / 2000D

- Fast print speed achieved by one pass system
- Less moving part



Serial Printer

- High quality image achieved by multi pass system
- Discharge compensation system
- Lower cost per page than IJ printer due to



IJ Printer printing mechanism

SCC-4000D / 2000D

- Fast print speed achieved by one pass system
- Less moving part



Serial Printer

- High quality image achieved by multi pass system
- Discharge compensation system
- Lower cost per page than IJ printer due to



IJ Printer printing mechanism

SCC-4000D/2000D

- Fast print speed achieved by one pass system
- Less moving part



Serial Printer

- High quality image achieved by multi pass system
- Discharge more ink compared with one pass system
- Lower cost per page than IJ printer due to

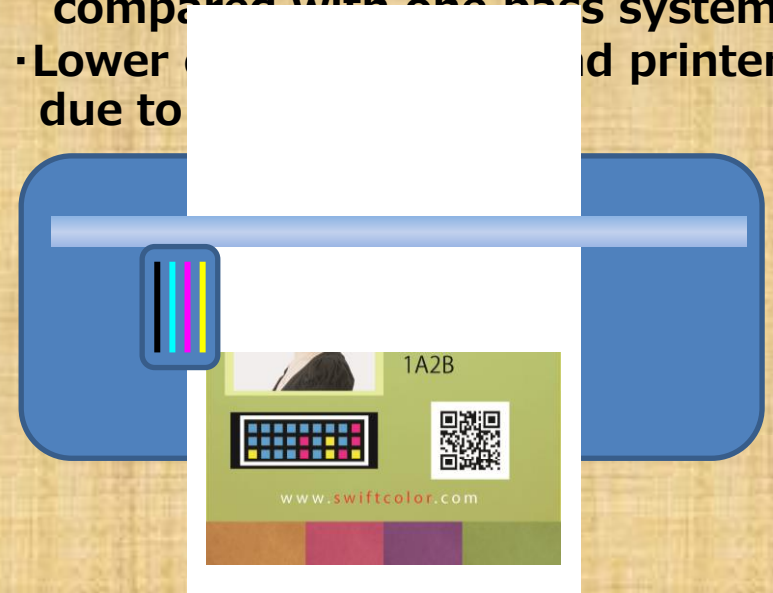

IJ Printer printing mechanism

SCC-4000D / 2000D

- Fast print speed achieved by one pass system
- Less moving part



Serial Printer

- High quality image achieved by multi pass system
- Discharge more ink compared with one pass system
- Lower cost per page than IJ printer due to



IJ Printer printing mechanism

SCC-4000D / 2000D

- Fast print speed achieved by one pass system
- Less moving part



Serial Printer

- High quality image achieved by multi pass system
- Discharge more ink compared with one pass system
- Lower cost per page than IJ printer due to

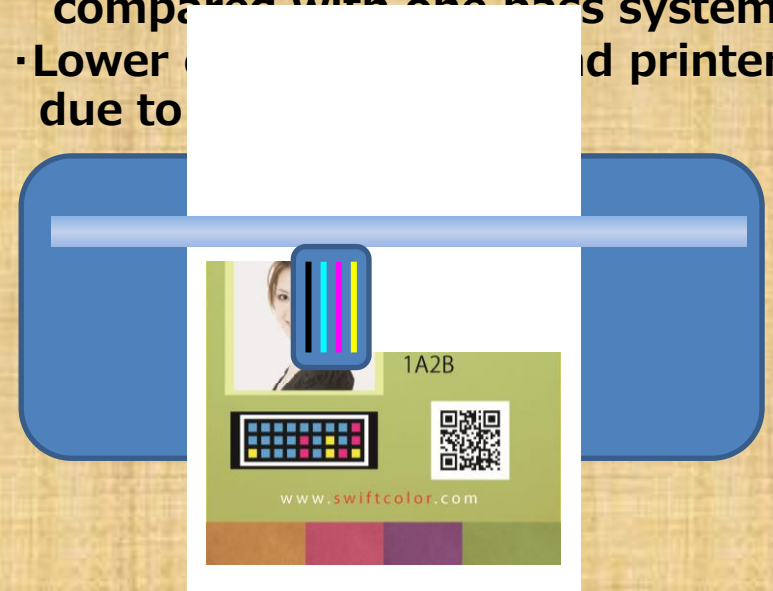

IJ Printer printing mechanism

SCC-4000D / 2000D

- Fast print speed achieved by one pass system
- Less moving part



Serial Printer

- High quality image achieved by multi pass system
- Discharge more ink compared with one pass system
- Lower cost per page than IJ printer due to



IJ Printer printing mechanism

SCC-4000D/2000D

- Fast print speed achieved by one pass system
- Less moving part



Serial Printer

- High quality image achieved by multi pass system
- Discharge more ink compared with one pass system
- Lower cost per page than IJ printer due to



IJ Printer printing mechanism

SCC-4000D / 2000D

- Fast print speed achieved by one pass system
- Less moving part



Serial Printer

- High quality image achieved by multi pass system
- Discharge more ink compared with one pass system
- Lower cost per page than IJ printer due to

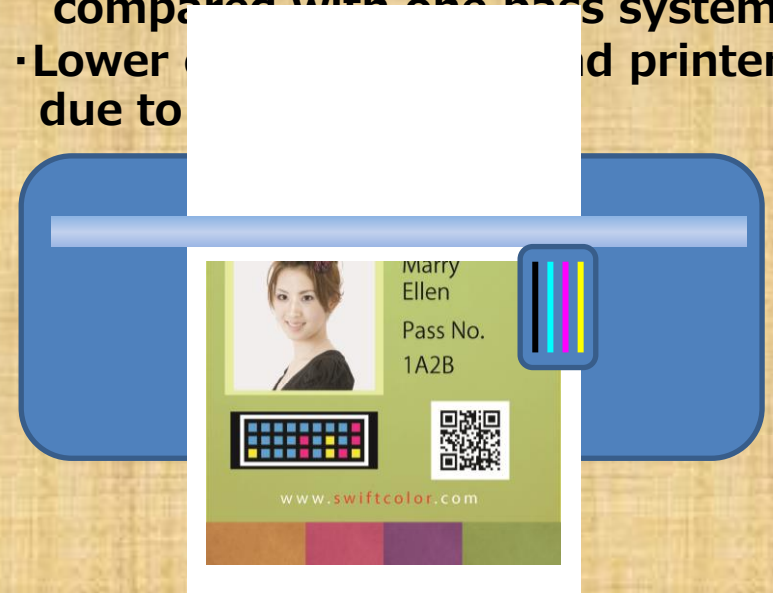

IJ Printer printing mechanism

SCC-4000D/2000D

- Fast print speed achieved by one pass system
- Less moving part



Serial Printer

- High quality image achieved by multi pass system
- Discharge more ink compared with one pass system
- Lower cost per page than IJ printer due to

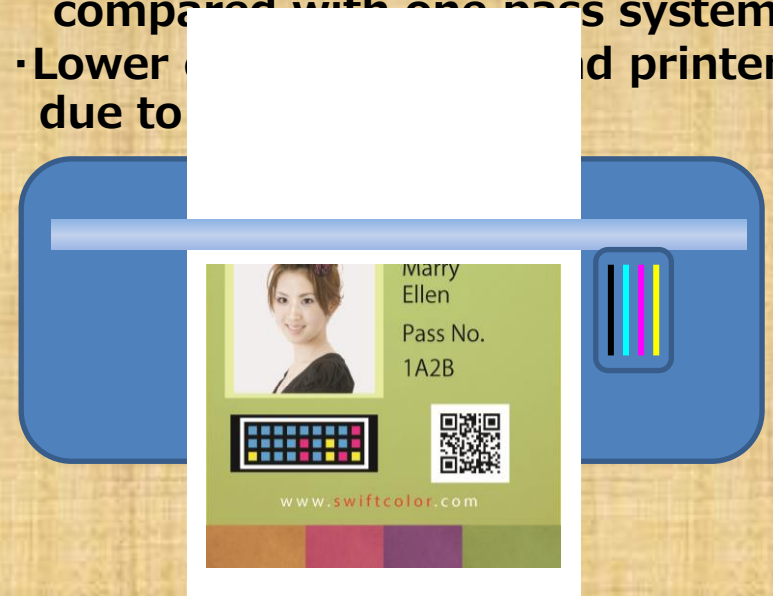

IJ Printer printing mechanism

SCC-4000D / 2000D

- Fast print speed achieved by one pass system
- Less moving part



Serial Printer

- High quality image achieved by multi pass system
- Discharge more ink compared with one pass system
- Lower cost than line head printer due to

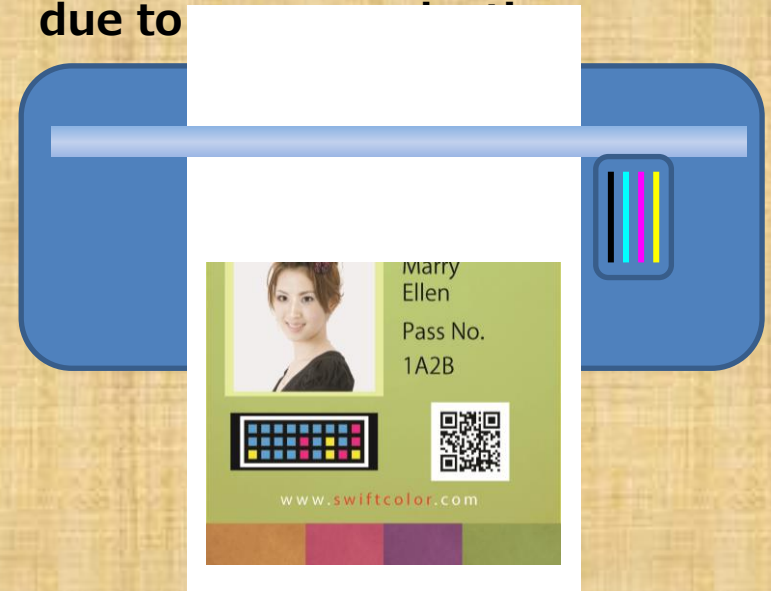

IJ Printer printing mechanism

SCC-4000D / 2000D

- Fast print speed achieved by one pass system
- Less moving part



Serial Printer

- High quality image achieved by multi pass system
- Discharge more ink compared with one pass system
- Lower cost than line head printer due to

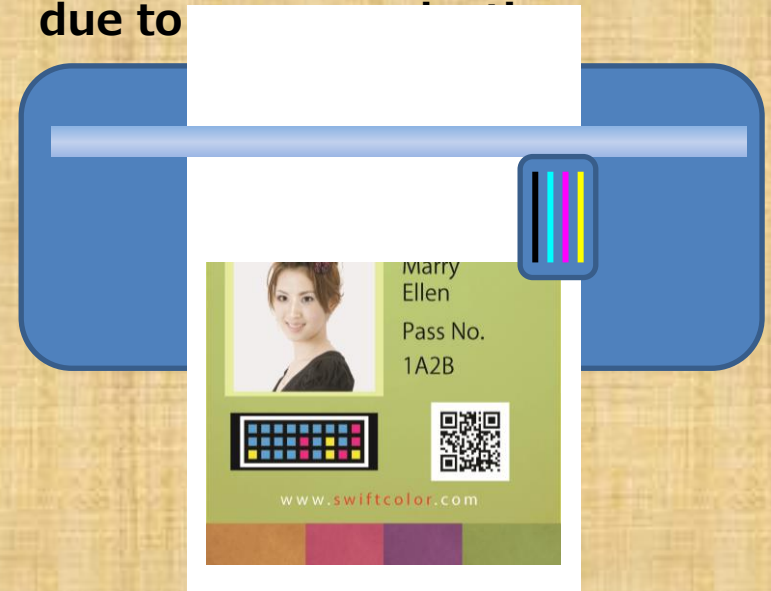

IJ Printer printing mechanism

SCC-4000D / 2000D

- Fast print speed achieved by one pass system
- Less moving part



Serial Printer

- High quality image achieved by multi pass system
- Discharge more ink compared with one pass system
- Lower cost than line head printer due to

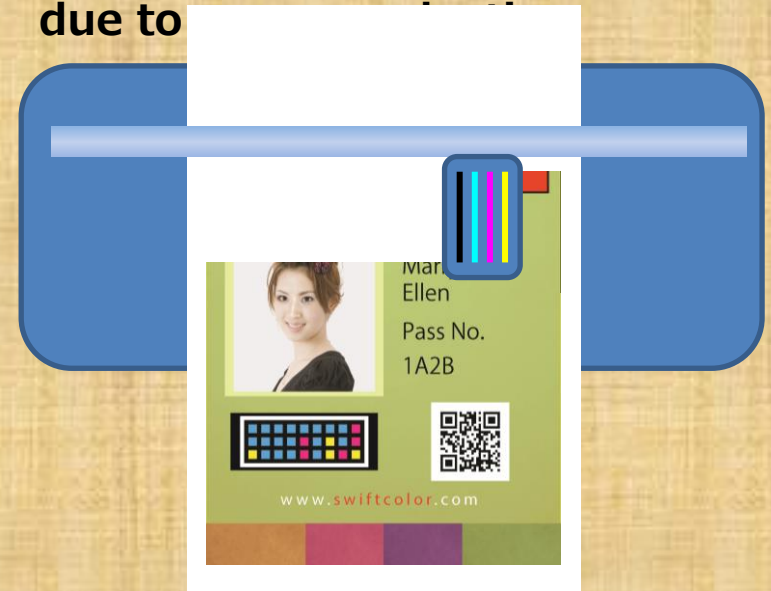

IJ Printer printing mechanism

SCC-4000D / 2000D

- Fast print speed achieved by one pass system
- Less moving part



Serial Printer

- High quality image achieved by multi pass system
- Discharge more ink compared with one pass system
- Lower cost than line head printer due to

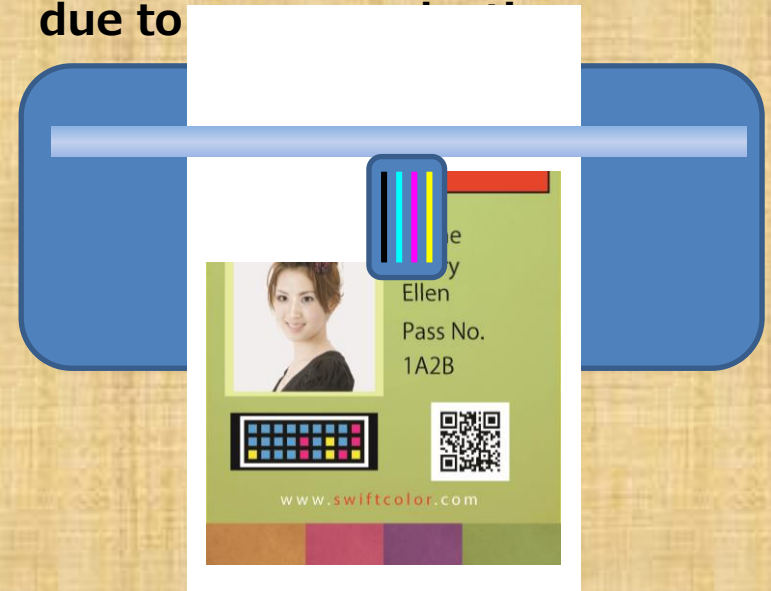

IJ Printer printing mechanism

SCC-4000D / 2000D

- Fast print speed achieved by one pass system
- Less moving part



Serial Printer

- High quality image achieved by multi pass system
- Discharge more ink compared with one pass system
- Lower cost than line head printer due to

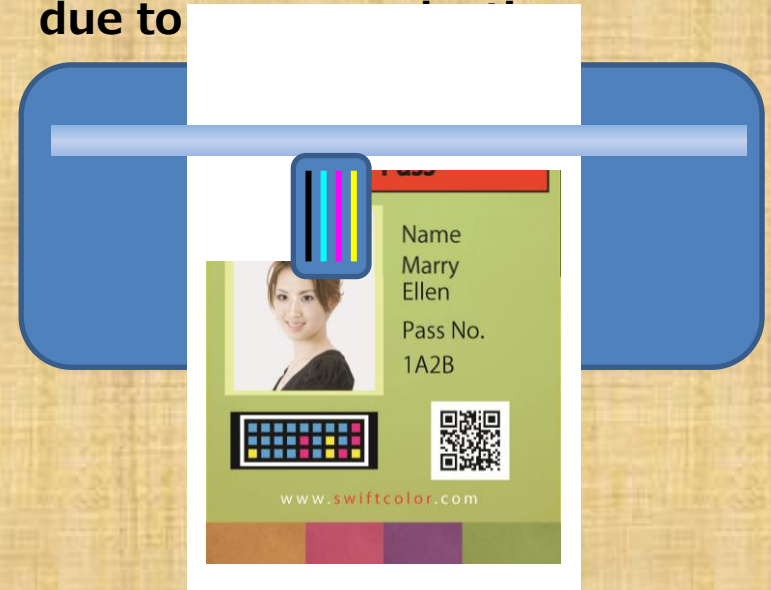

IJ Printer printing mechanism

SCC-4000D/2000D

- Fast print speed achieved by one pass system
- Less moving part



Serial Printer

- High quality image achieved by multi pass system
- Discharge more ink compared with one pass system
- Lower cost than line head printer due to

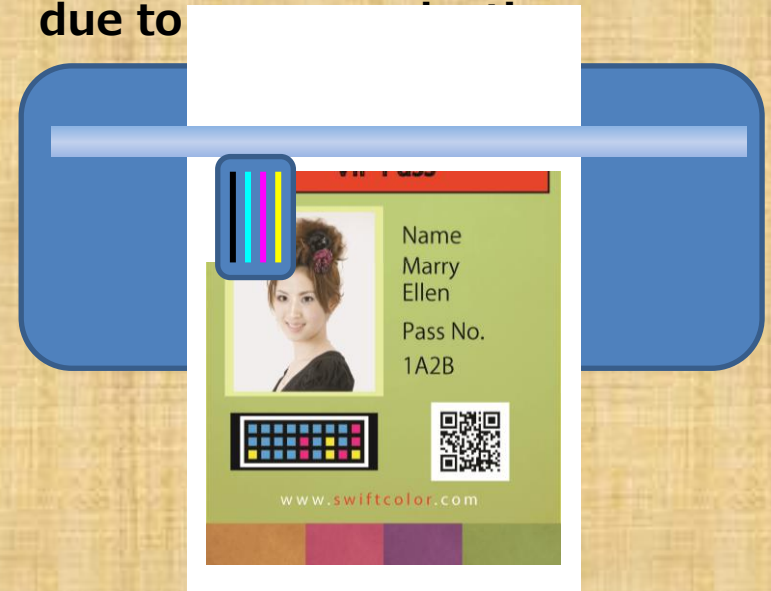

IJ Printer printing mechanism

SCC-4000D / 2000D

- Fast print speed achieved by one pass system
- Less moving part



Serial Printer

- High quality image achieved by multi pass system
- Discharge more ink compared with one pass system
- Lower cost than line head printer due to

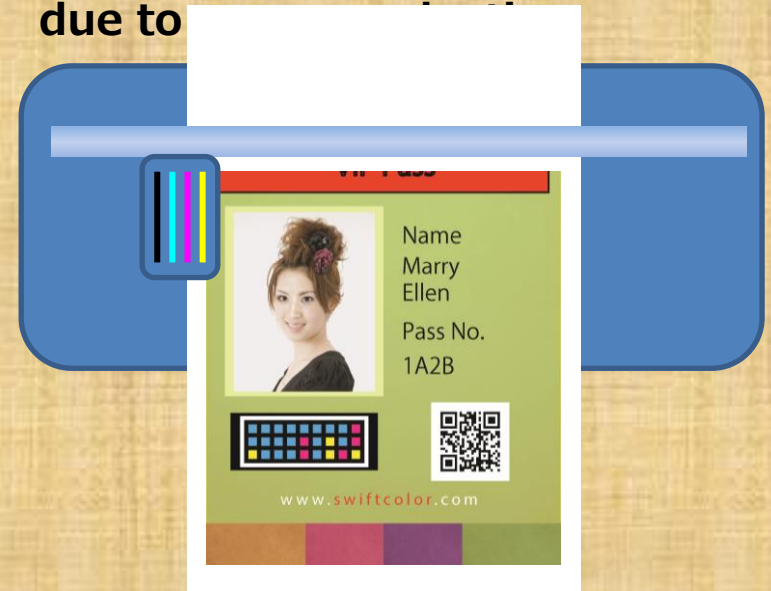

IJ Printer printing mechanism

SCC-4000D / 2000D

- Fast print speed achieved by one pass system
- Less moving part



Serial Printer

- High quality image achieved by multi pass system
- Discharge more ink compared with one pass system
- Lower cost than line head printer due to mass production

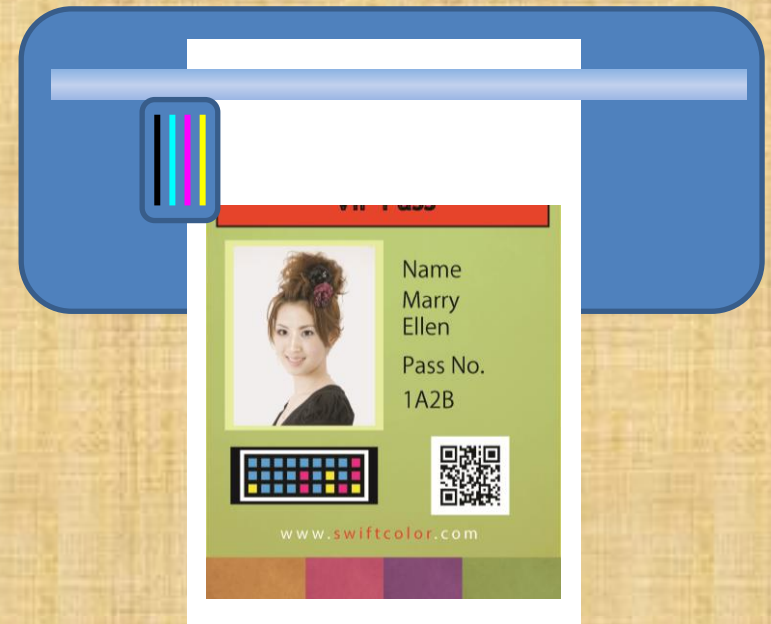

IJ Printer printing mechanism

SCC-4000D/2000D

- Fast print speed achieved by one pass system
- Less moving part



Serial Printer

- High quality image achieved by multi pass system
- Discharge more ink compared with one pass system
- Lower cost than line head printer due to mass production

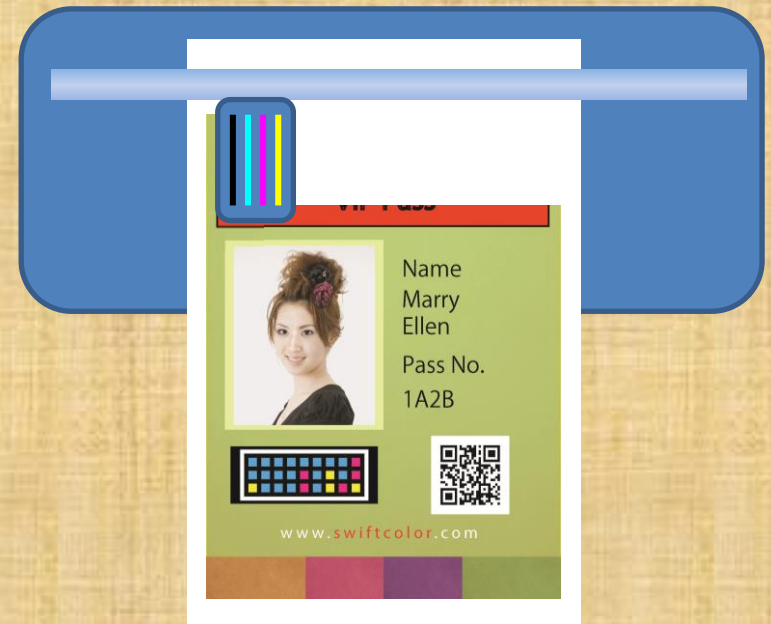

IJ Printer printing mechanism

SCC-4000D / 2000D

- Fast print speed achieved by one pass system
- Less moving part



Serial Printer

- High quality image achieved by multi pass system
- Discharge more ink compared with one pass system
- Lower cost than line head printer due to mass production

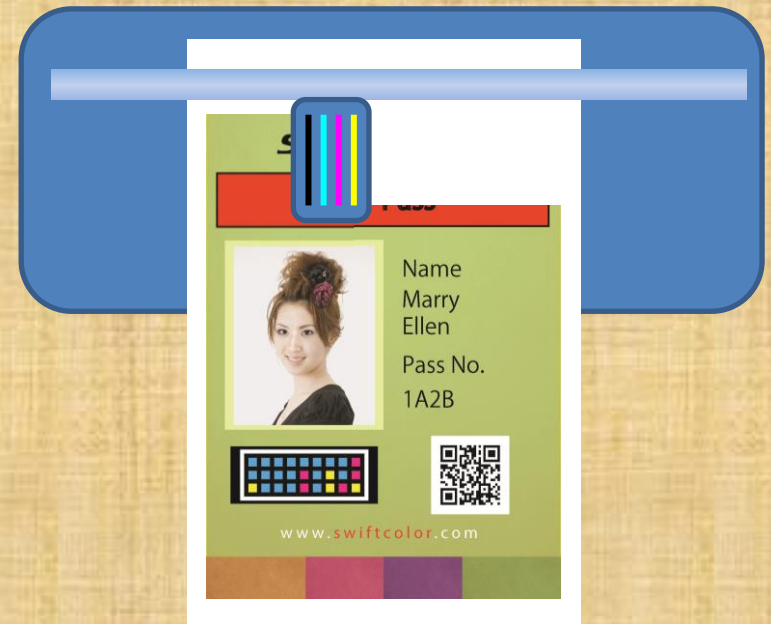

IJ Printer printing mechanism

SCC-4000D / 2000D

- Fast print speed achieved by one pass system
- Less moving part



Serial Printer

- High quality image achieved by multi pass system
- Discharge more ink compared with one pass system
- Lower cost than line head printer due to mass production

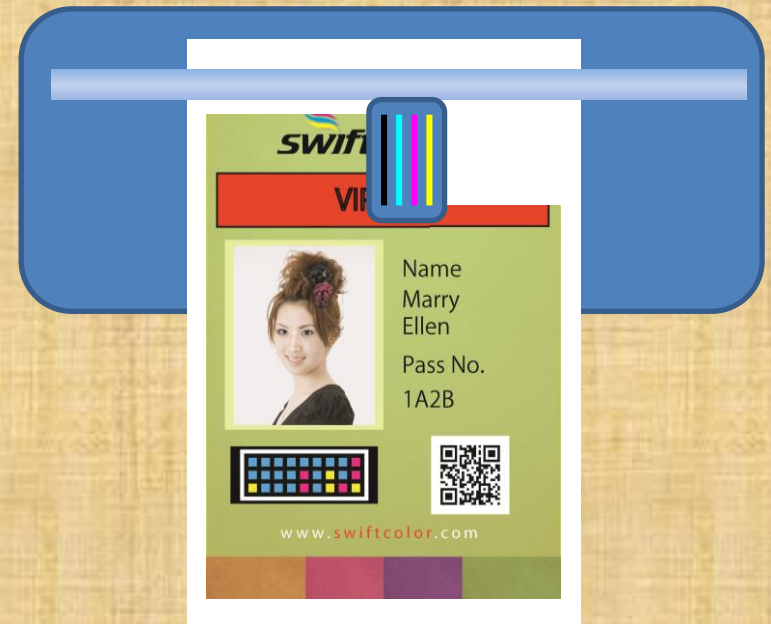

IJ Printer printing mechanism

SCC-4000D / 2000D

- Fast print speed achieved by one pass system
- Less moving part



Serial Printer

- High quality image achieved by multi pass system
- Discharge more ink compared with one pass system
- Lower cost than line head printer due to mass production



IJ Printer printing mechanism

SCC-4000D / 2000D

- Fast print speed achieved by one pass system
- Less moving part



Serial Printer

- High quality image achieved by multi pass system
- Discharge more ink compared with one pass system
- Lower cost than line head printer due to mass production

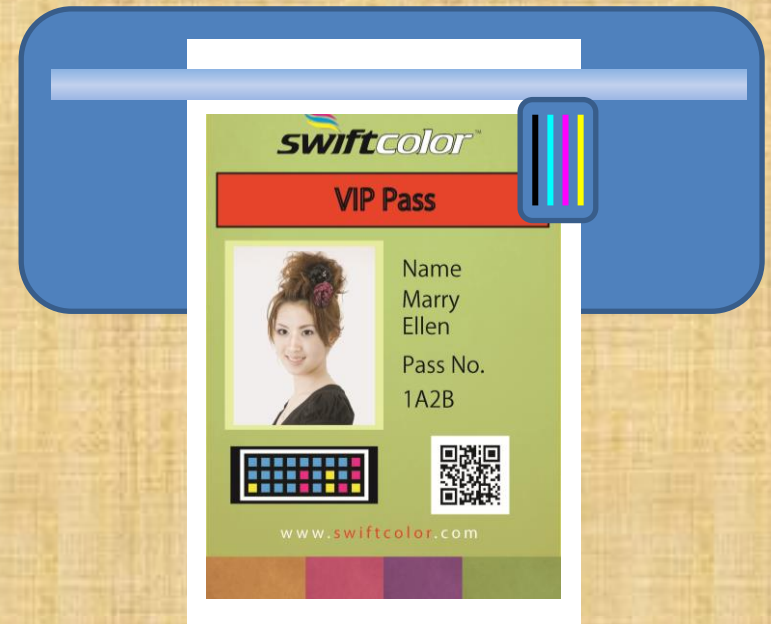

IJ Printer printing mechanism

SCC-4000D / 2000D

- Fast print speed achieved by one pass system
- Less moving part



Serial Printer

- High quality image achieved by multi pass system
- Discharge more ink compared with one pass system
- Lower cost than line head printer due to mass production

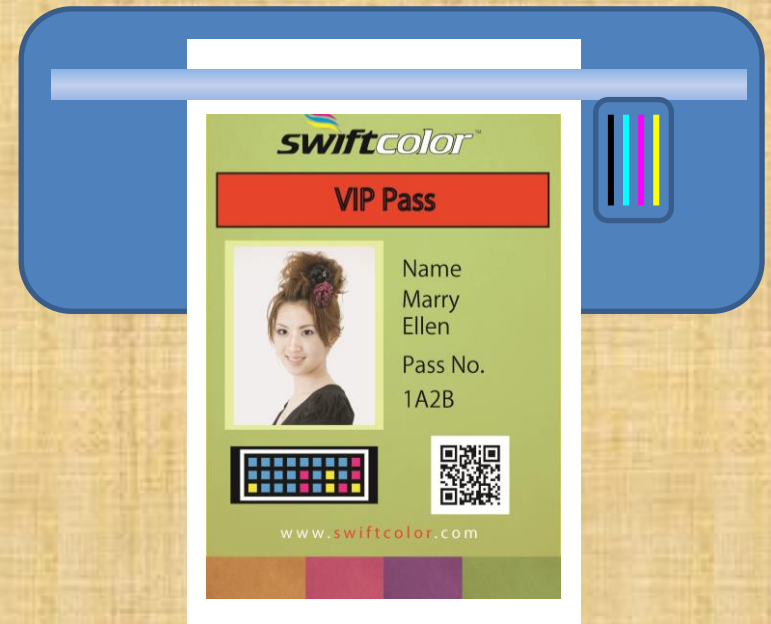

IJ Printer printing mechanism

SCC-4000D / 2000D

- Fast print speed achieved by one pass system
- Less moving part



Serial Printer

- High quality image achieved by multi pass system
- Discharge more ink compared with one pass system
- Lower cost than line head printer due to mass production



IJ Printer printing mechanism

SCC-4000D / 2000D

- Fast print speed achieved by one pass system
- Less moving part



Serial Printer

- High quality image achieved by multi pass system
- Discharge more ink compared with one pass system
- Lower cost than line head printer due to mass production



IJ Printer printing mechanism

SCC-4000D / 2000D

- Fast print speed achieved by one pass system
- Less moving part



Serial Printer

- High quality image achieved by multi pass system
- Discharge more ink compared with one pass system
- Lower cost than line head printer due to mass production



IJ Printer printing mechanism

SCC-4000D / 2000D

- Fast print speed achieved by one pass system
- Less moving part



Serial Printer

- High quality image achieved by multi pass system
- Discharge more ink compared with one pass system
- Lower cost than line head printer due to mass production



IJ Printer printing mechanism

SCC-4000D / 2000D

- Fast print speed achieved by one pass system
- Less moving part



Serial Printer

- High quality image achieved by multi pass system
- Discharge more ink compared with one pass system
- Lower cost than line head printer due to mass production



IJ Printer printing mechanism

SCC-4000D / 2000D

- Fast print speed achieved by one pass system
- Less moving part



Serial Printer

- High quality image achieved by multi pass system
- Discharge more ink compared with one pass system
- Lower cost than line head printer due to mass production



IJ Printer printing mechanism

SCC-4000D / 2000D

- Fast print speed achieved by one pass system
- Less moving part



Serial Printer

- High quality image achieved by multi pass system
- Discharge more ink compared with one pass system
- Lower cost than line head printer due to mass production



Bias in used nozzles

Line head Printer

Due to the feature of line printing system, particular nozzles are used frequently for printing parallel line to media feeding direction. As a result, the head life is shortened and it affects cost per page.

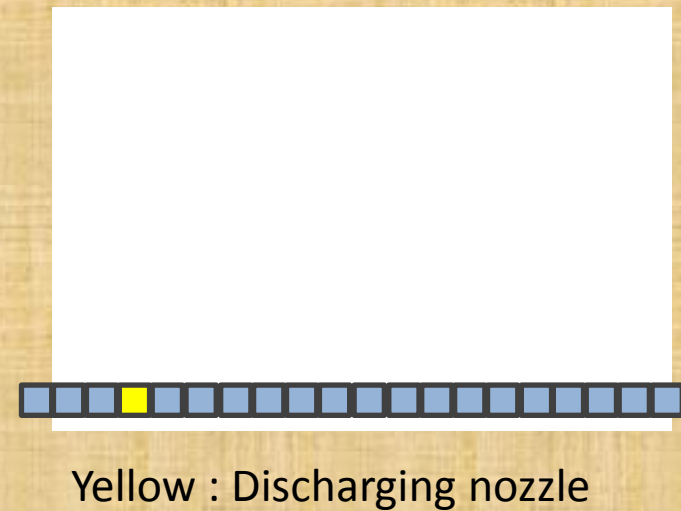
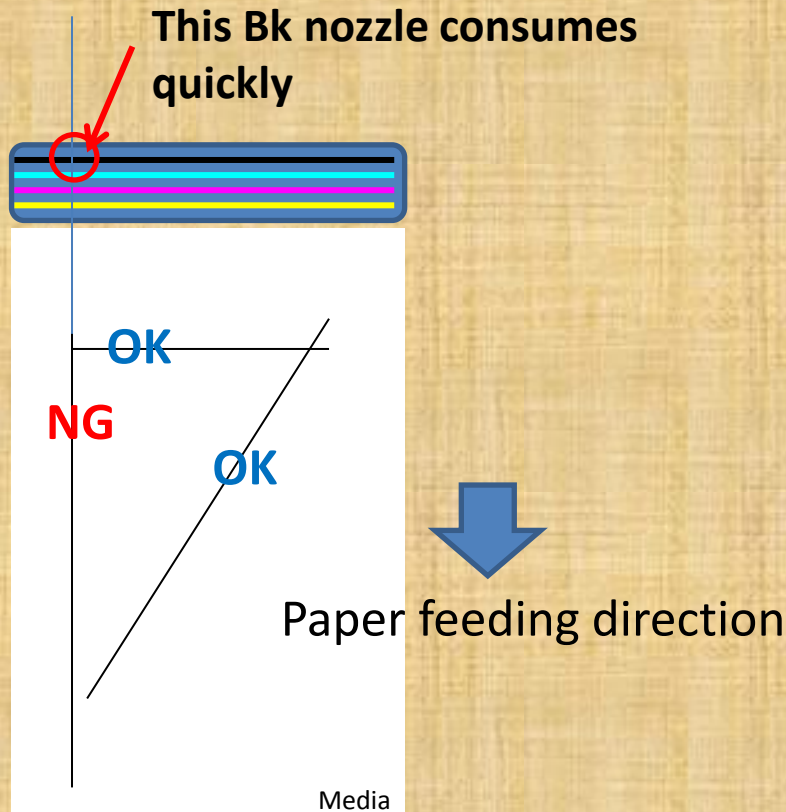

Bias in used nozzles

Line head Printer

Due to the feature of line printing system, particular nozzles are used frequently for printing parallel line to media feeding direction. As a result, the head life is shortened and it affects cost per page.

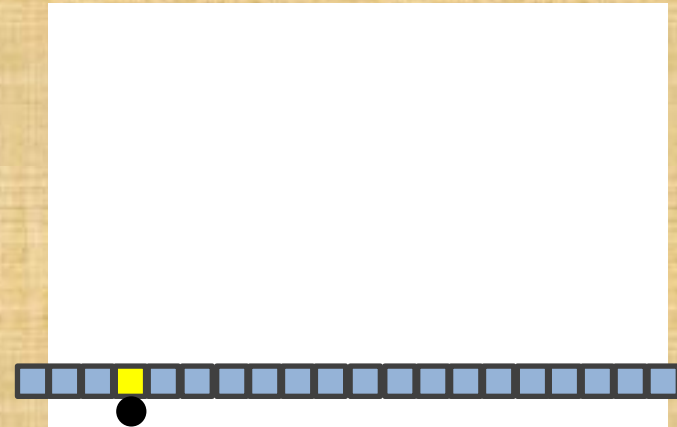
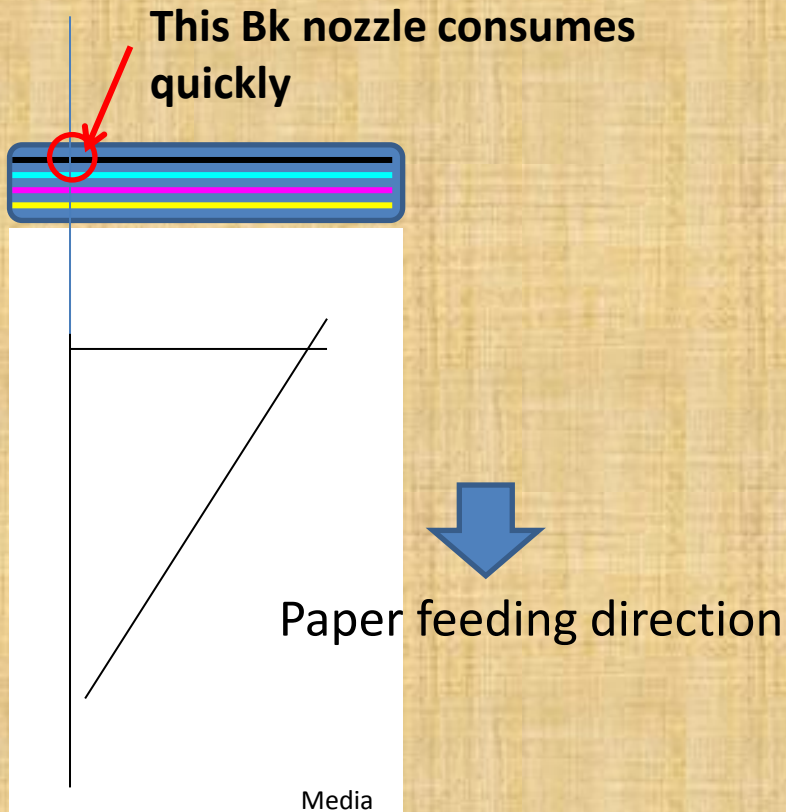

Bias in used nozzles

Line head Printer

Due to the feature of line printing system, particular nozzles are used frequently for printing parallel line to media feeding direction. As a result, the head life is shortened and it affects cost per page.

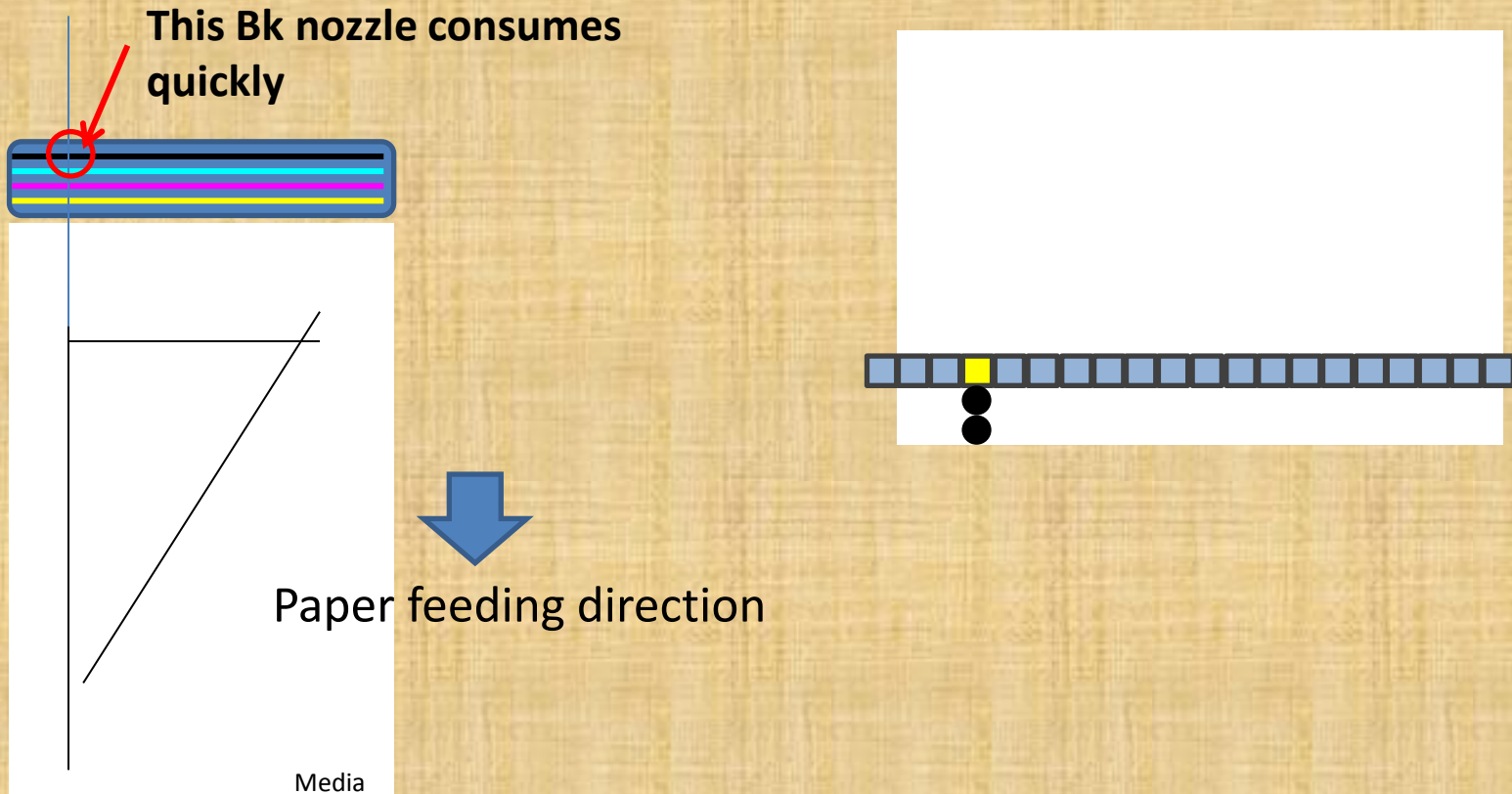

Bias in used nozzles

Line head Printer

Due to the feature of line printing system, particular nozzles are used frequently for printing parallel line to media feeding direction. As a result, the head life is shortened and it affects cost per page.

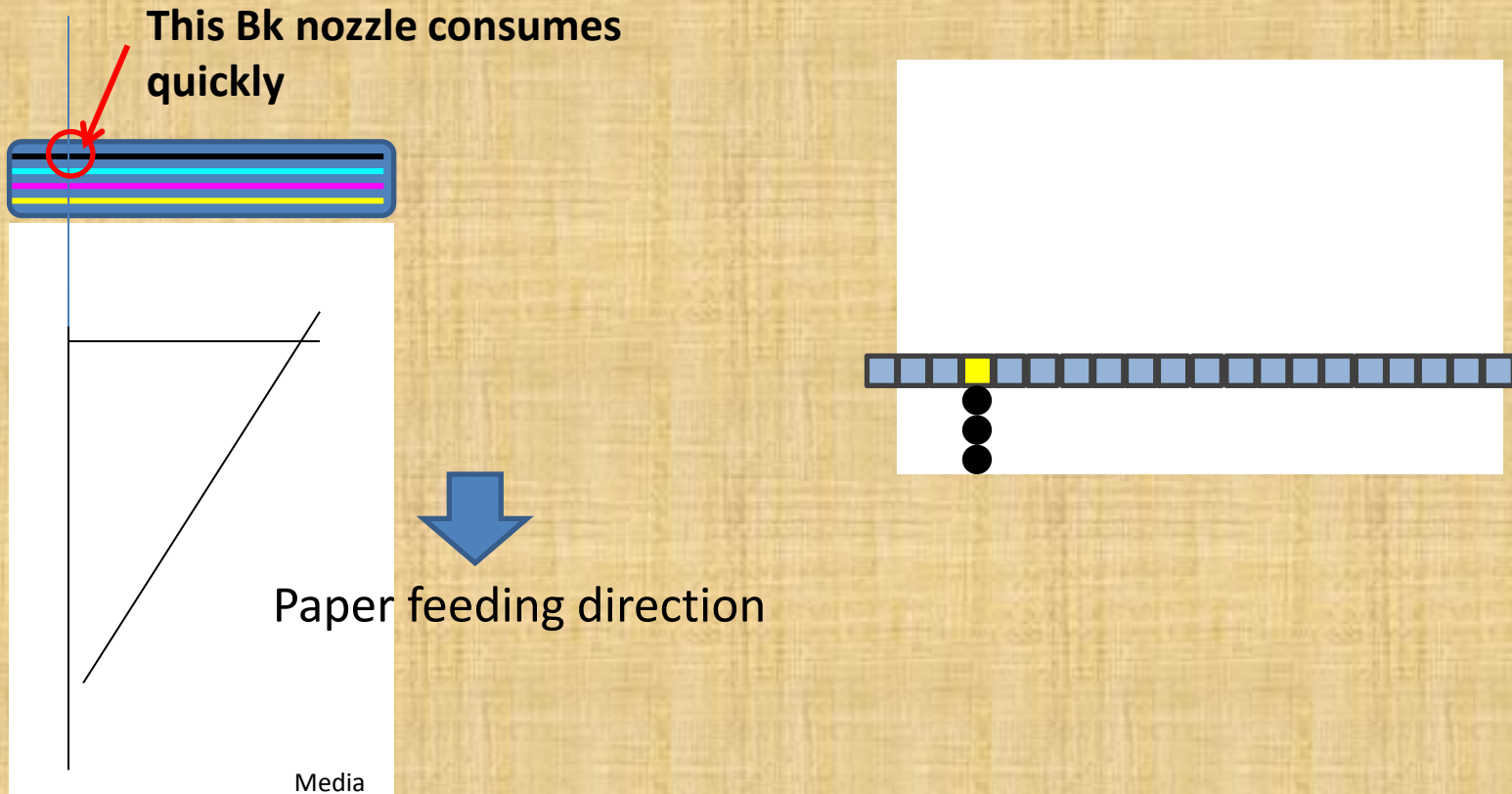

Bias in used nozzles

Line head Printer

Due to the feature of line printing system, particular nozzles are used frequently for printing parallel line to media feeding direction. As a result, the head life is shortened and it affects cost per page.

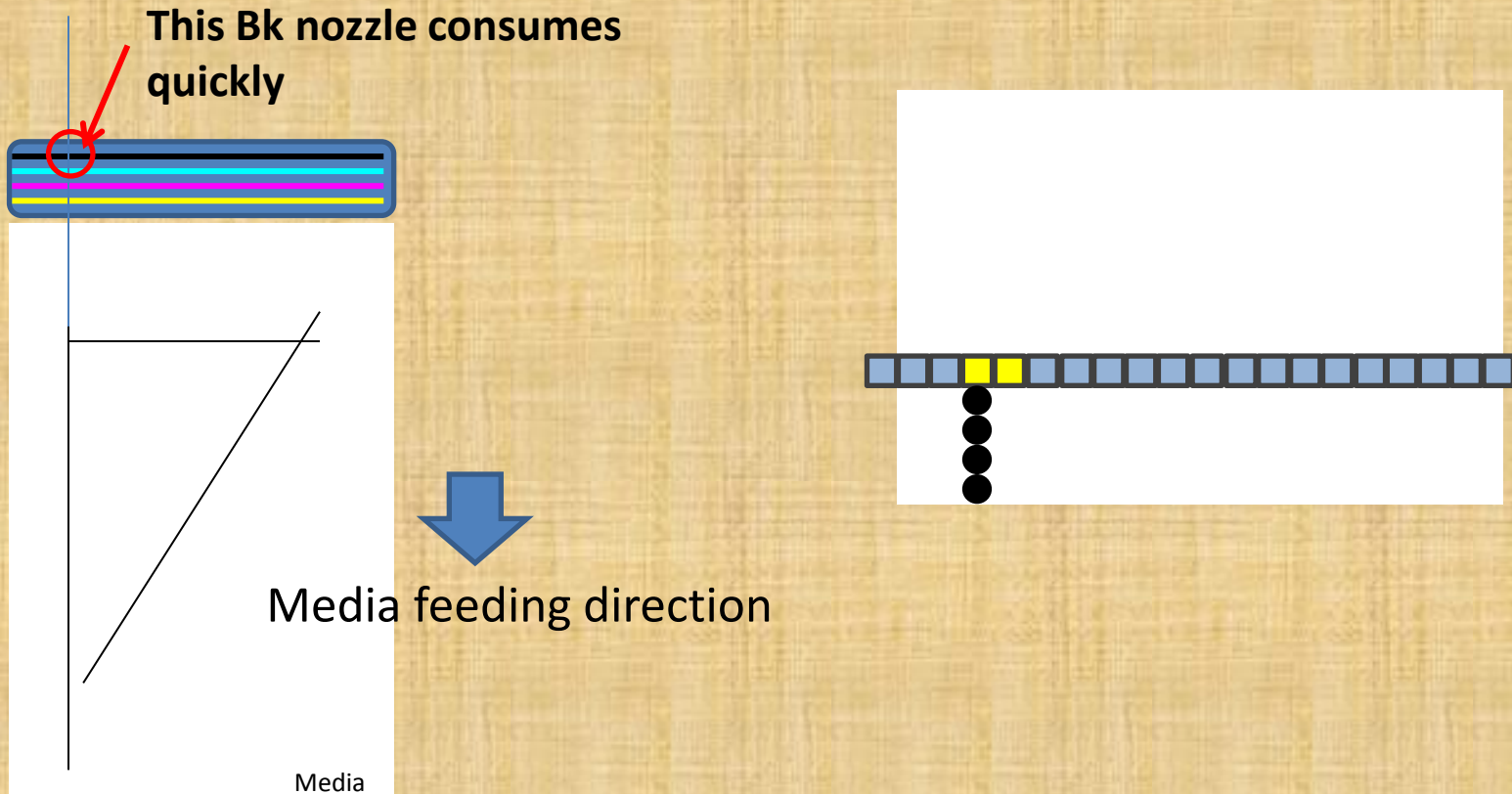

Bias in used nozzles

Line head Printer

Due to the feature of line printing system, particular nozzles are used frequently for printing parallel line to media feeding direction. As a result, the head life is shortened and it affects cost per page.

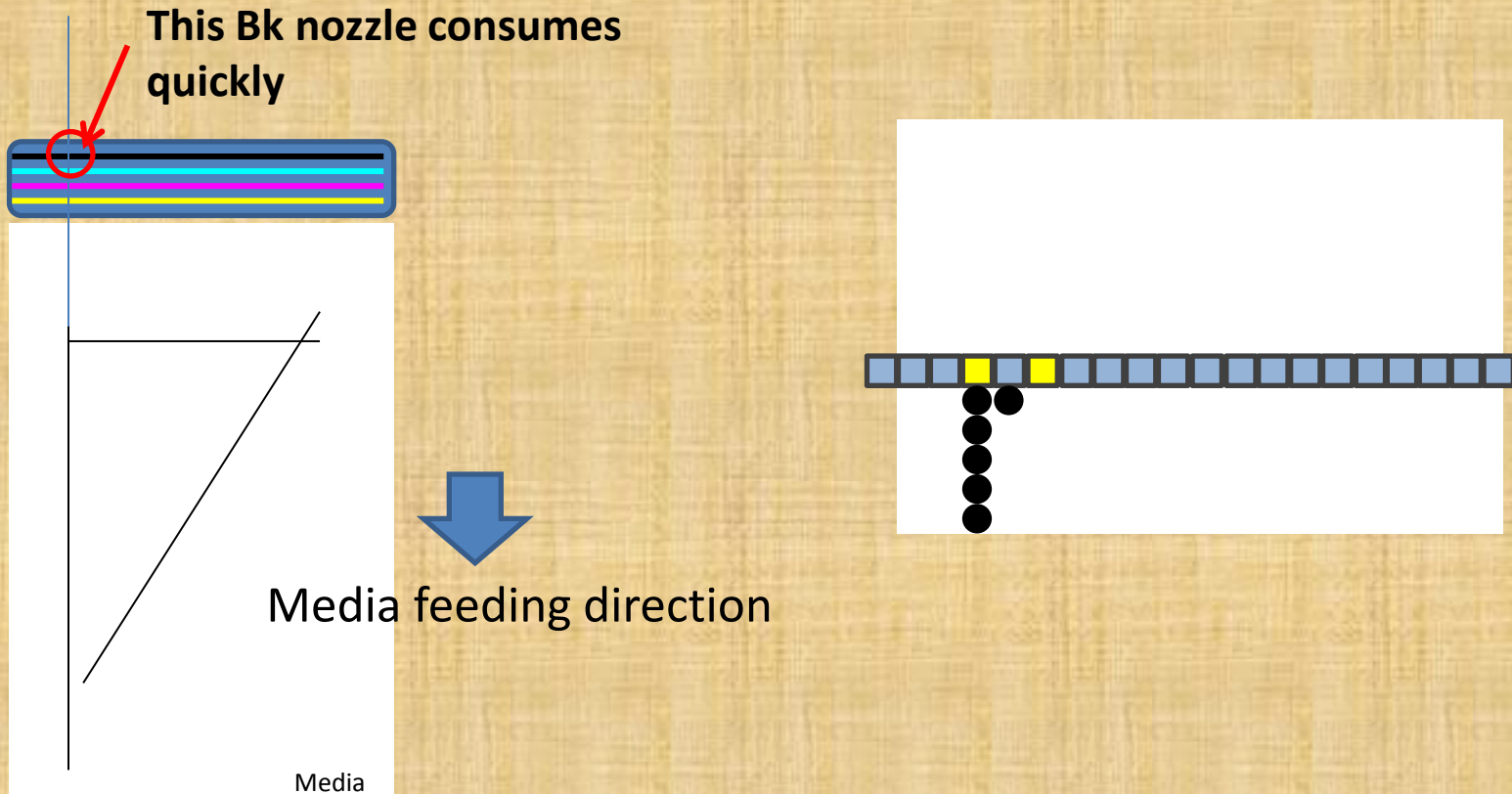

Bias in used nozzles

Line head Printer

Due to the feature of line printing system, particular nozzles are used frequently for printing parallel line to media feeding direction. As a result, the head life is shortened and it affects cost per page.

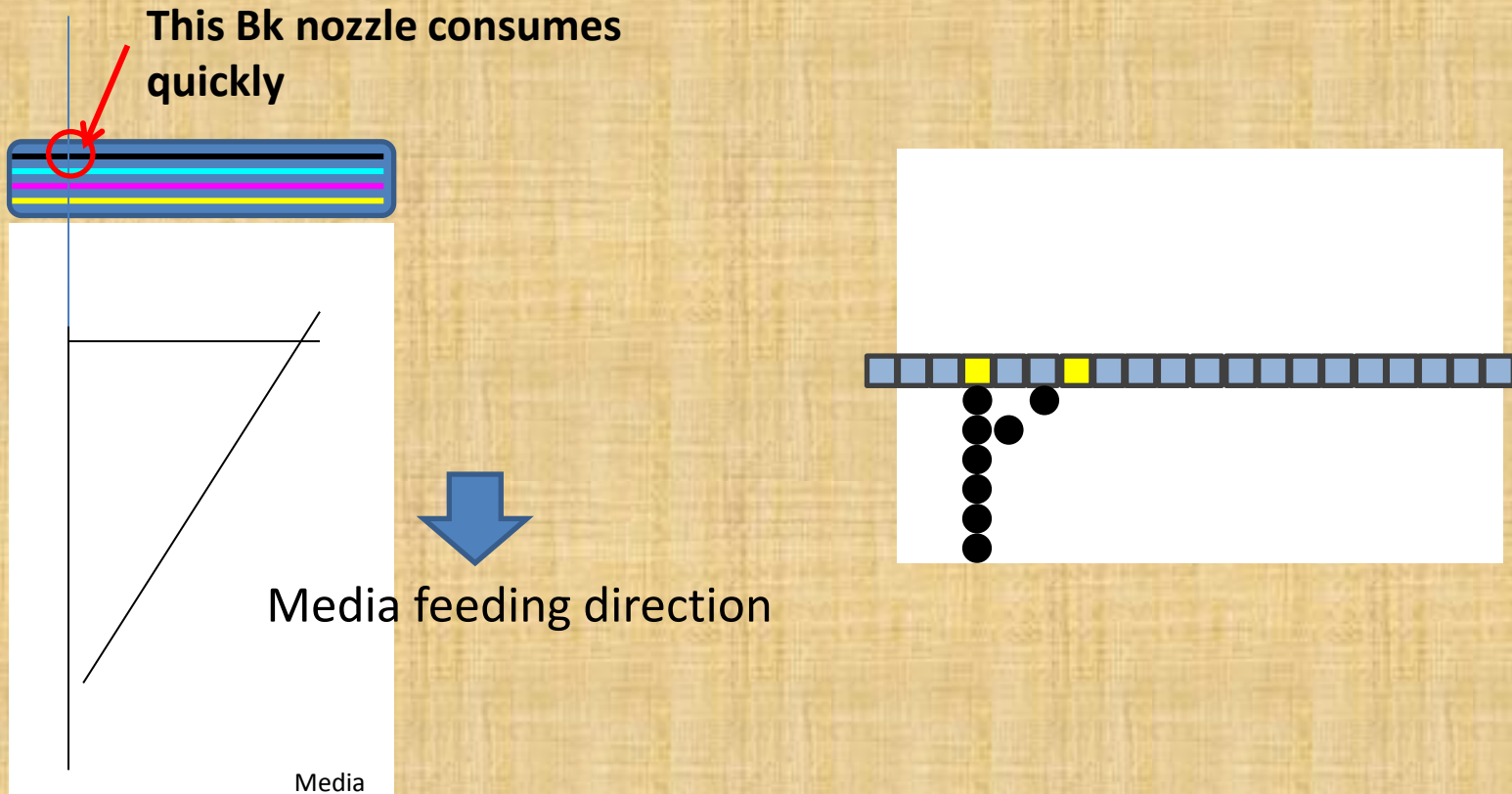

Bias in used nozzles

Line head Printer

Due to the feature of line printing system, particular nozzles are used frequently for printing parallel line to media feeding direction. As a result, the head life is shortened and it affects cost per page.

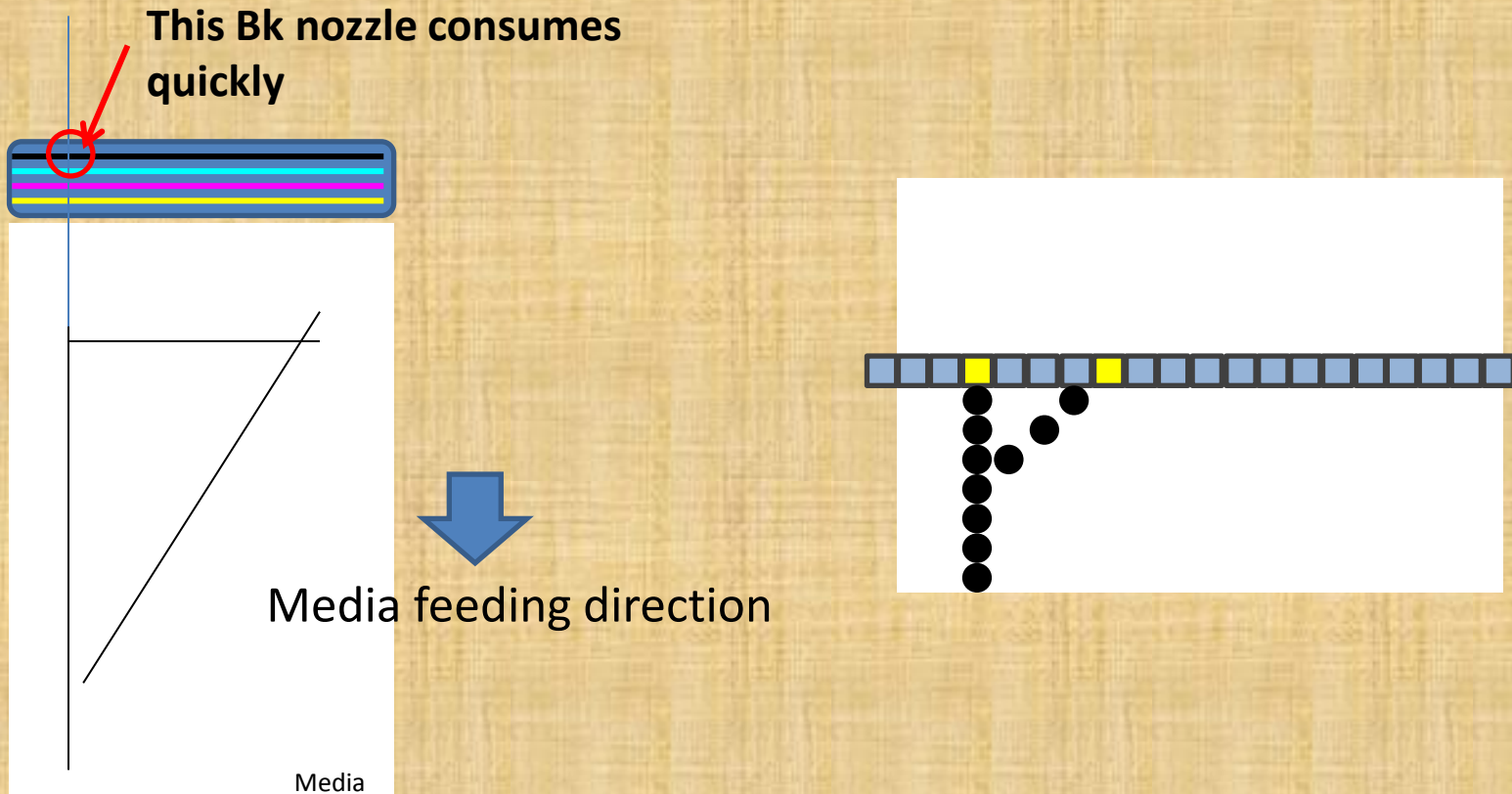

Bias in used nozzles

Line head Printer

Due to the feature of line printing system, particular nozzles are used frequently for printing parallel line to media feeding direction. As a result, the head life is shortened and it affects cost per page.

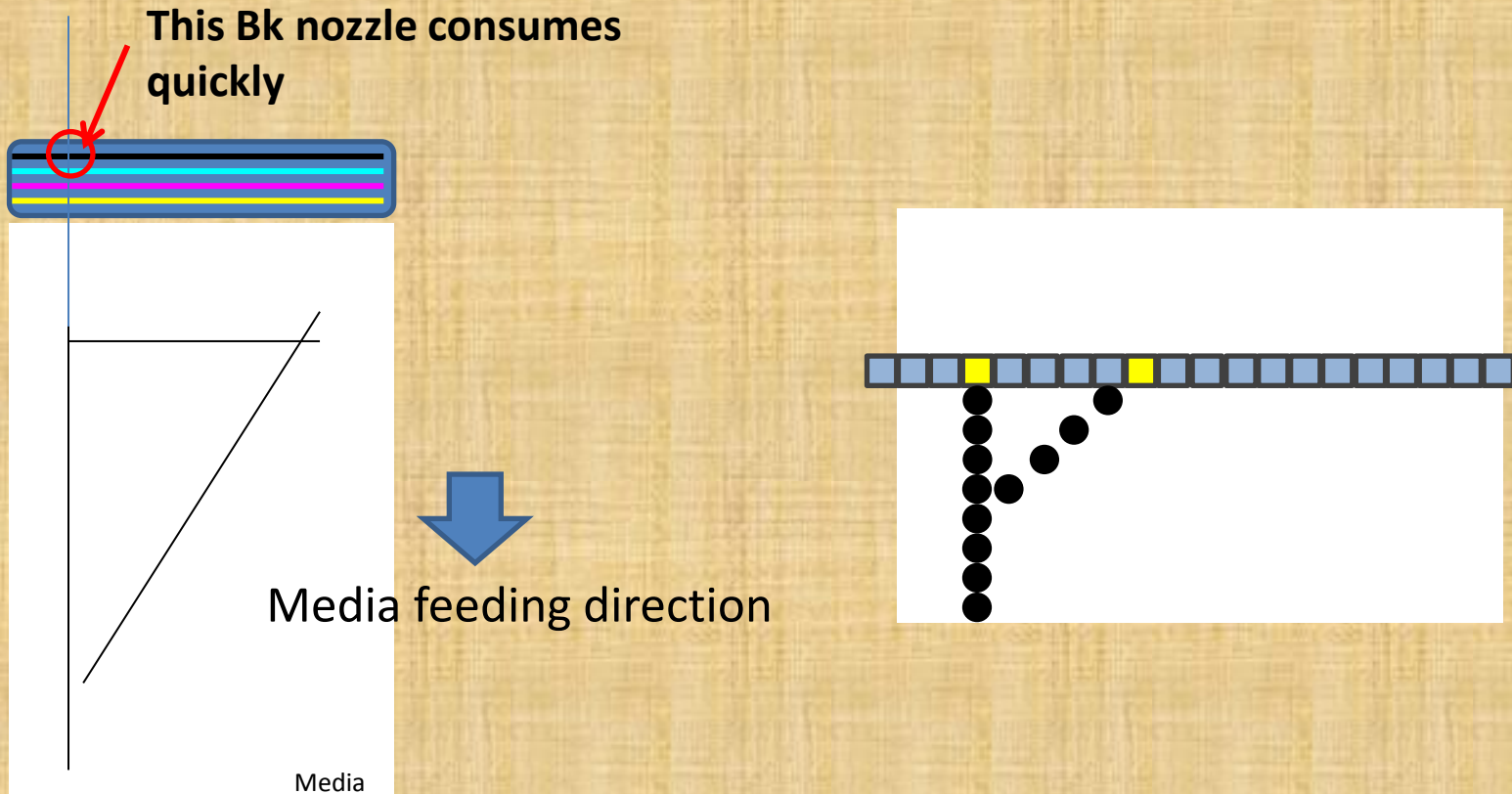

Bias in used nozzles

Line head Printer

Due to the feature of line printing system, particular nozzles are used frequently for printing parallel line to media feeding direction. As a result, the head life is shortened and it affects cost per page.

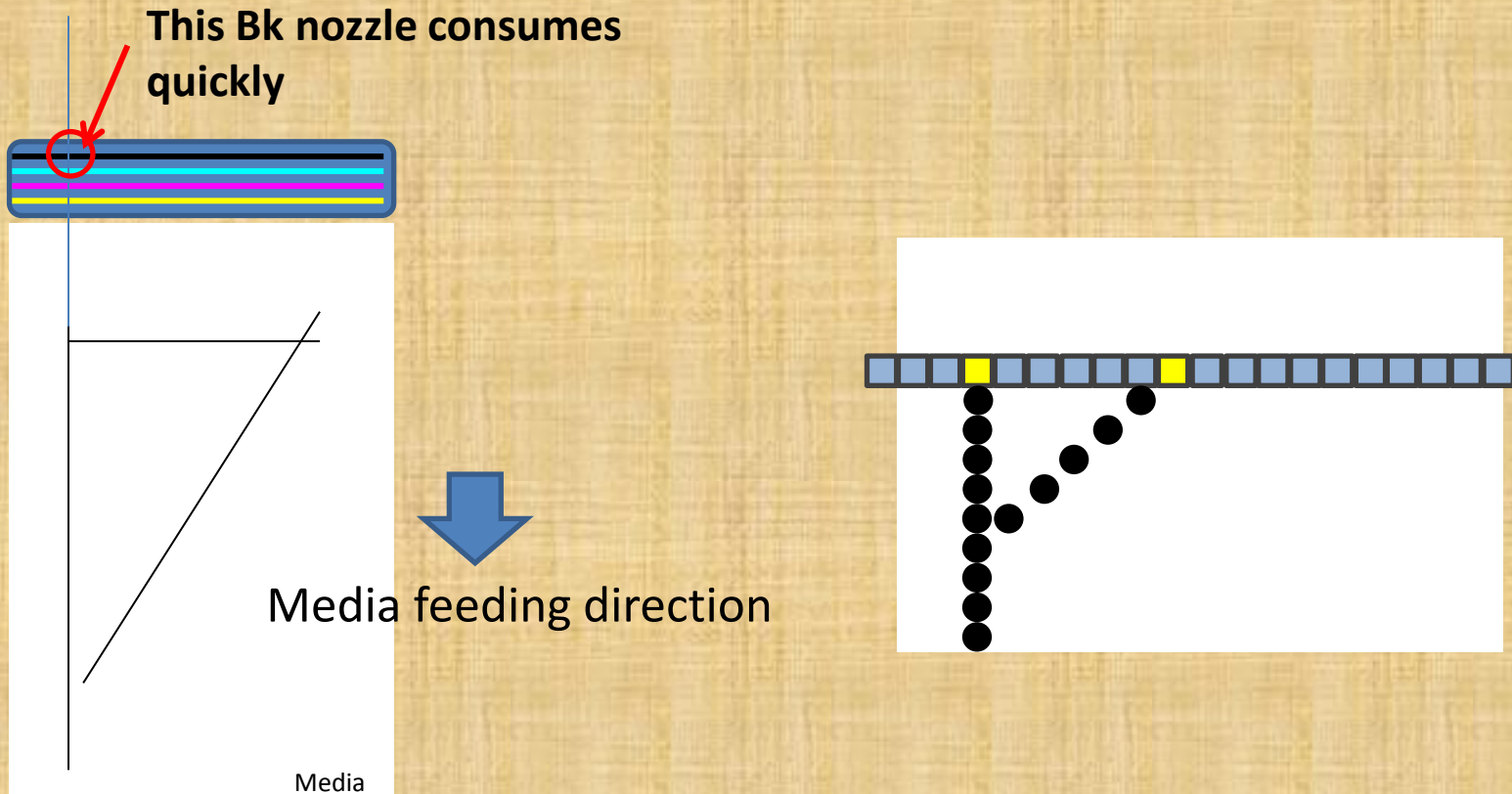

Bias in used nozzles

Line head Printer

Due to the feature of line printing system, particular nozzles are used frequently for printing parallel line to media feeding direction. As a result, the head life is shortened and it affects cost per page.

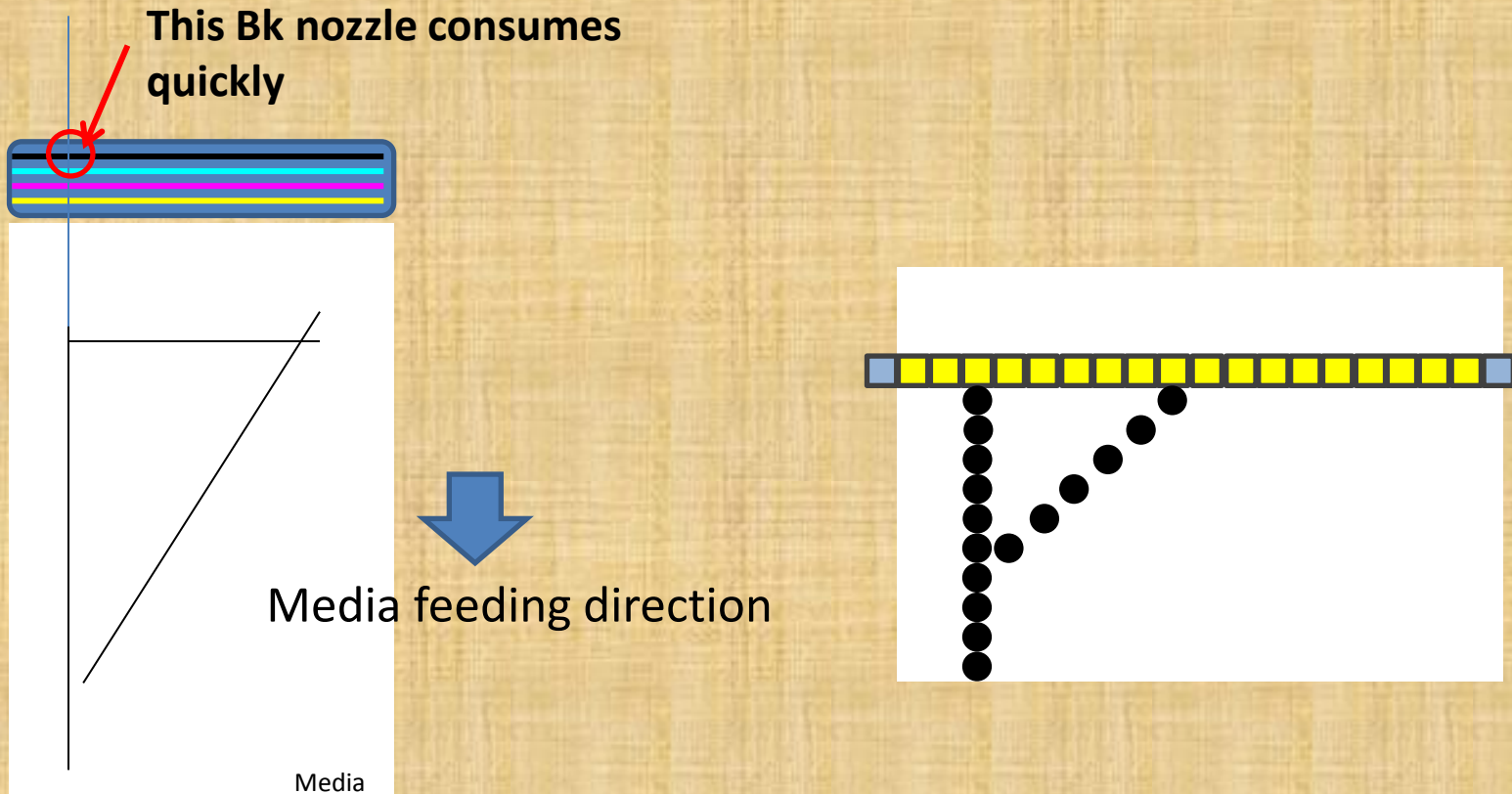

Bias in used nozzles

Line head Printer

Due to the feature of line printing system, particular nozzles are used frequently for printing parallel line to media feeding direction. As a result, the head life is shortened and it affects cost per page.

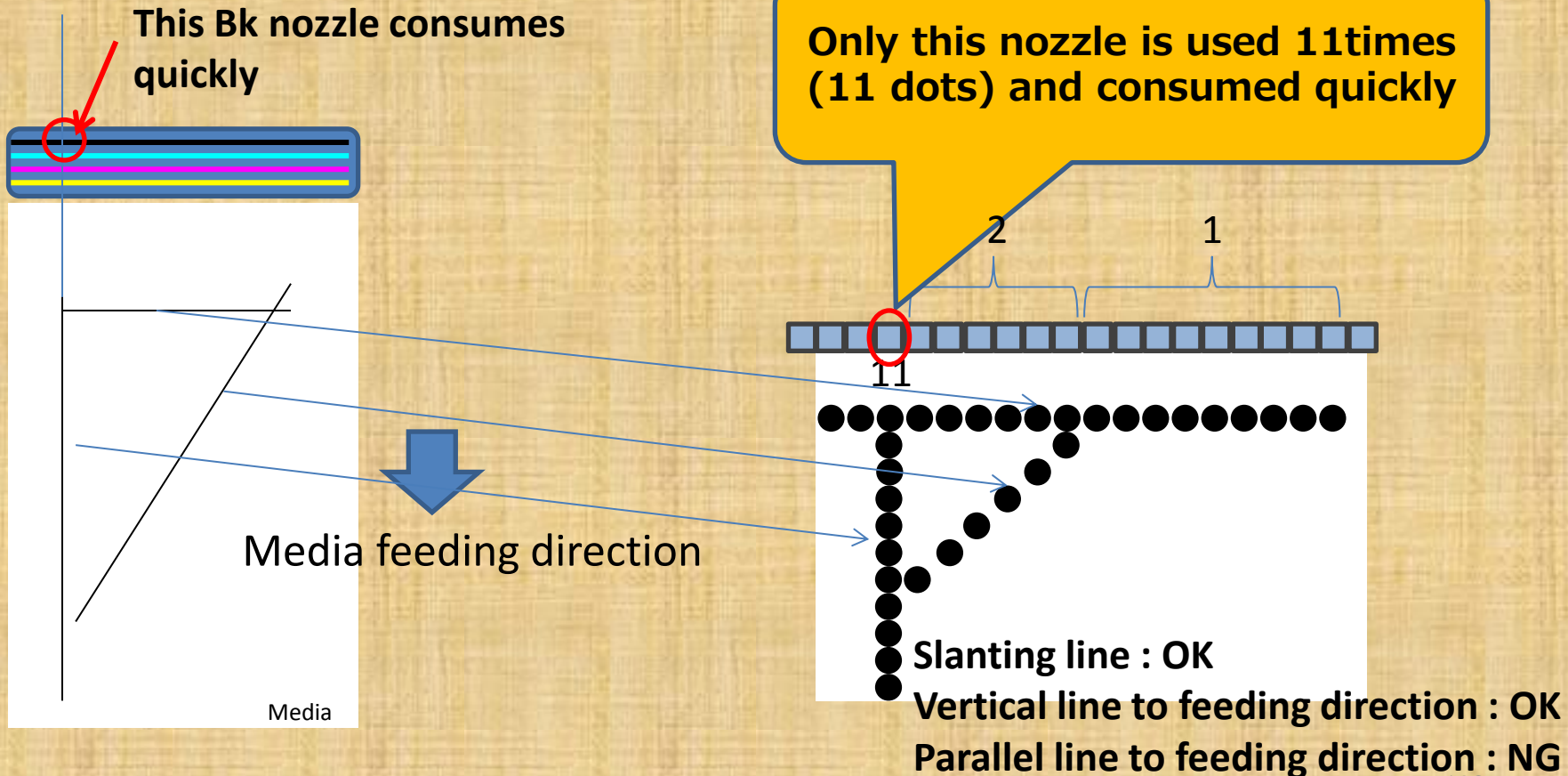

Key to Design image suitable for SCC printer

SCC-2000D / Extend Print-head Life cycle (Intermittent printing)

Before improvement



Delete surrounding frame borders

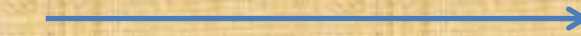

Media feeding direction



Lighten background color

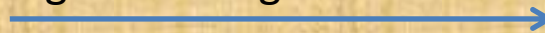

After improvement



SCC-2000D, Head life

Intermittent printing

350,000 cards

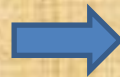

SCC-2000D, Head life

Intermittent printing

400,000 cards

Considering 2inch printer mechanism, above design sample doesn't influence the head life significantly since there are not many parallel lines to media feeding direction.

Before improvement : **350,000 cards** → After improvement : **400,000 cards**

Key to Design image suitable for SCC printer

SCC-4000D / Print-head Life cycle (Intermittent printing)

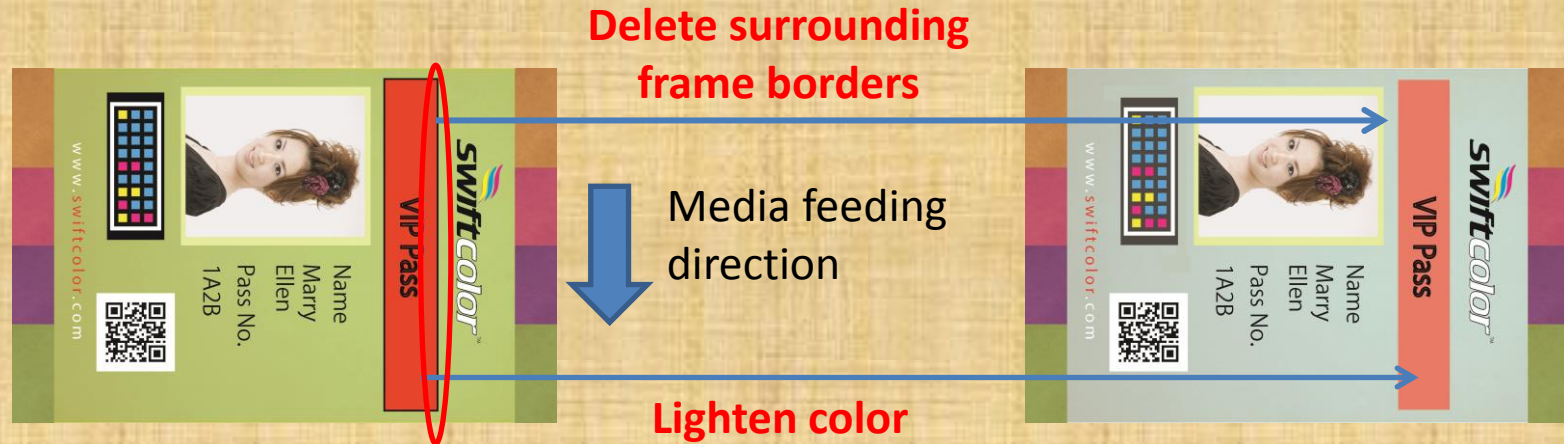

SCC-4000D、Head life	
Intermittent printing	130,000 cards



SCC-4000D、Head life	
Intermittent printing	260,000 cards

In total, due to mechanical difference between SCC-2000D and SCC-4000D, Above Image design keys are more effective for SCC-4000D.

■ Before improvement

Portrait(2"): 350,000cards / Landscape(4"): 130,000cards

■ After improvement

Portrait(2"): 400,000 cards / Landscape(4"): 260,000card

POINT!!

Key point is to avoid using lines (Line parallel to the Media feeding direction.) and frames with dark color figures.

Appendix. Swift design image sample

; Sample image which is suitable for Swiftcolor printer mechanism



Point!

- Light color gradation
- Use no lines, no frame borders

SCC-4000D:

Intermittent printing **300,000 cards** Continuous printing **500,000cards**

SCC-2000D:

Intermittent printing **360,000 cards** Continuous printing **400,000 cards**

In addition: There aren't significant difference in head life between models with above image.

>> In case calculating and comparing both 2" and 4" head life, image which does not result in significant difference between models are more suitable.

Appendix. Continuous printing / Intermittent printing

Features of each model(4inch/2inch)

2inch Printer:

Head life is affected less by intermittent printing achieved by improved cleaning sequence

4inch Printer:

In case of intermittent printing, large amount of ink is consumed for cleaning before printing, this sequence is more suitable for continuous printing or larger volume printing, but it would consume print head as well.

2" and 4" printer mechanism/ sequence differs depending on each printers target market.

Product Concept/ Target

- **For large volume continuous printing**
SCC-4000D
- **For low volume intermittent printing**
SCC-2000D